A group of people are gathered around an outdoor dining table. In the foreground, a woman with long dark hair is focused on serving food from a large, shiny metal bowl onto a white plate. To her left, a woman with long blonde hair is smiling and looking towards the camera. Another person is visible in the background, also engaged in the meal. The table is set with various dishes, including a plate of salad and a plate of what appears to be grilled or roasted food. The background shows green foliage and a stone wall, suggesting an outdoor restaurant or cafe setting. The lighting is warm, indicating it might be late afternoon or early evening.

FORGE ADOUR

ÍNDICE



Raíces

La historia de una marca auténtica ■ *Página 08*

Diseño

El arte de la belleza ■ *Página 10*

Innovación

Diseñar hoy las planchas del mañana ■ *Página 12*

Cocina

La alegría de los placeres sanos ■ *Página 16*

Diseño ecológico

Modelar el mundo del mañana ■ *Página 18*

Servicios

Simplificar la felicidad ■ *Página 20*

Gamas

■ *Página 22*

Series de PLANCHAS ■ *Página 24*

Serie PREMIUM ■ *Página 26*

Serie MODERN ■ *Página 36*

Serie ORIGIN ■ *Página 46*

Serie BASE ■ *Página 52*

Serie COOKING ■ *Página 58*

Serie COMBI ■ *Página 62*

COCINAS exteriores ■ *Página 68*

PARRILLAS ■ *Página 78*

UTENSILIOS Y ACCESORIOS ■ *Página 82*

Vivir
la

felicidad
a diario

Diseño

El arte de la belleza

En Forge Adour, una plancha no es solo un objeto, sino un objeto bello. Mirarla debe ser un placer; el primero antes de usarla.

Con sus líneas, materiales y colores, debe encajar a

la perfección en su hogar. Con su tamaño y funcionalidad, usarla también tiene que ser un placer. Por eso, esta

combinación de belleza y funcionalidad está en el centro del proceso de diseño de nuestras planchas y cocinas exteriores. Tal es el reto al que

se enfrentan los diseñadores a los que recurrimos para crear cada uno de nuestros productos.

*Una plancha
o una cocina exterior
de Forge Adour no
se parece a ninguna otra*

Su elegancia, modernidad y practicidad hacen de ella una fuente atemporal de placer.





the amount
of gas is
regulated
by the
valve

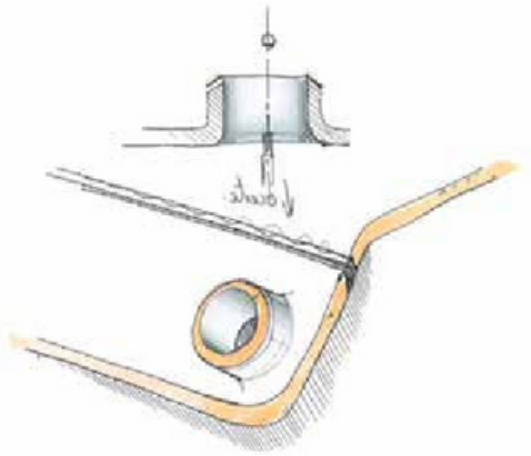



ELÉCTRICAS



GAS



SIN DISOLVENTES



AHORRO ENERGÉTICO



GARANTÍA



Diseñar una plancha que dure años, robusta y con una garantía de hasta 15 años significa mirar siempre hacia el futuro. Este es el objetivo de nuestro departamento de investigación: buscar y utilizar los materiales más duraderos y resistentes, e innovar para ofrecer productos más eficientes en materia de energía.

Utilizamos un revestimiento de tres capas sin disolventes en todos los componentes de acero, con la etiqueta Smart Certified de categoría

Platinum, para garantizar el diseño ecológico del producto y una mejor resistencia a la corrosión, los rayos UV y los impactos.

Nuestros productos están disponibles en versiones de gas o eléctricas, y los modelos de gas de nueva generación ofrecen un ahorro energético de hasta

el 30 %.

En esta línea, nuestras cocinas exteriores están diseñadas con el mismo compromiso y los mismos estándares de calidad, para ofrecer productos



La alegría de los **placeres** sanos

Cocinar con Forge Adour es simplemente aunar el «comer bien» con el «alimentarse bien». Gracias a su modo de cocina, nuestras planchas sacan lo mejor de los alimentos, utilizando un mínimo de grasa y permitiendo que se concentre y caramelicé, preservando su verdadero sabor y carácter.

*Todo un mundo
de placeres le espera.
Basta con elegir
productos de calidad
y de temporada.*



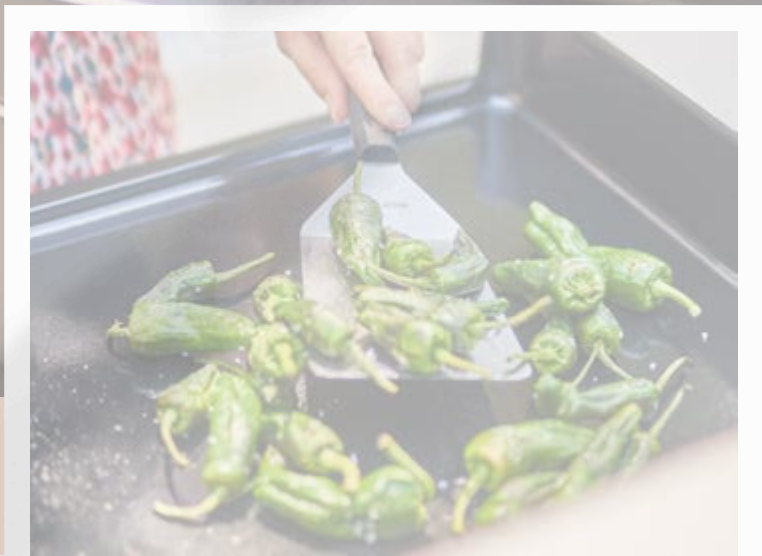

Diseño ecológico

Modelar el mundo del mañana

Mirar al futuro significa comprometerse con el mundo del mañana, el que dejaremos a nuestros hijos y a las generaciones venideras. Por eso, siempre hemos diseñado y fabricado productos que duran. En línea con este planteamiento, desde 2016 hemos apostado por el **enfoque del diseño ecológico** e integramos sistemáticamente aspectos medioambientales en el diseño de nuestros productos, con el **objetivo de reducir su impacto medioambiental a lo largo de su ciclo de vida.**

Un planteamiento de diseño ecológico que quiere encontrar el mejor equilibrio entre los requisitos medioambientales, sociales, técnicos y económicos.



ESTUDIO Y DISEÑO

FABRICACIÓN

TRANSPORTE

USO

FIN DE VIDA

Estudio y diseño



DISEÑO ECOLÓGICO



- Diseño atemporal
- Productos fáciles de montar
- Productos duraderos (garantía de hasta 15 años*)
- Productos reparables (piezas de repuesto disponibles durante un mínimo de 10 años)
- Comercialización de productos de limpieza con diseño ecológico (para reducir el impacto de los consumibles) y medios de protección
- Optimización continua de los productos

Materias primas



- 95 % de materiales reciclables
- Suministros europeos lo más cerca posible del centro de producción
- Selección de materiales de gran calidad
 - Acero inoxidable 304
 - Fundición esmaltada de hasta 7 mm (mejor conservación y distribución del calor)
- Embalaje de cartón reciclable con certificado FSC
- Impreso en papel FSC

Fabricación



SIN DISOLVENTES

- Uso de un revestimiento de tres capas sin disolventes y con etiqueta ecológica (mejor resistencia a la corrosión, los rayos UV y los impactos, y menos residuos de materias primas)
- Reciclaje de los restos de fabricación
- Aislamiento mediante cámara de combustión doble.

Uso



AHORRO ENERGÉTICO

- Hasta un 30 % de ahorro energético de media
- Consejos de la comunidad: montaje, uso, cocinado
- Servicio de mantenimiento y revisión

Fin de vida



- Servicio de reparaciones
- Venta de productos reacondicionados
- Pertenencia a organizaciones ecológicas: eco system, CITEO, eco-maison, re-fashion, screlec, Éco DDS

* según el modelo



Servicios

Simplificar la felicidad

La alegría de recibir

buenos consejos

Nuestro canal [forgeadour.tv](https://www.youtube.com/channel/UC...) te da acceso a una amplia gama de tutoriales de ayuda para el montaje, consejos de mantenimiento y limpieza, inspiración para recetas y consejos de cocina.

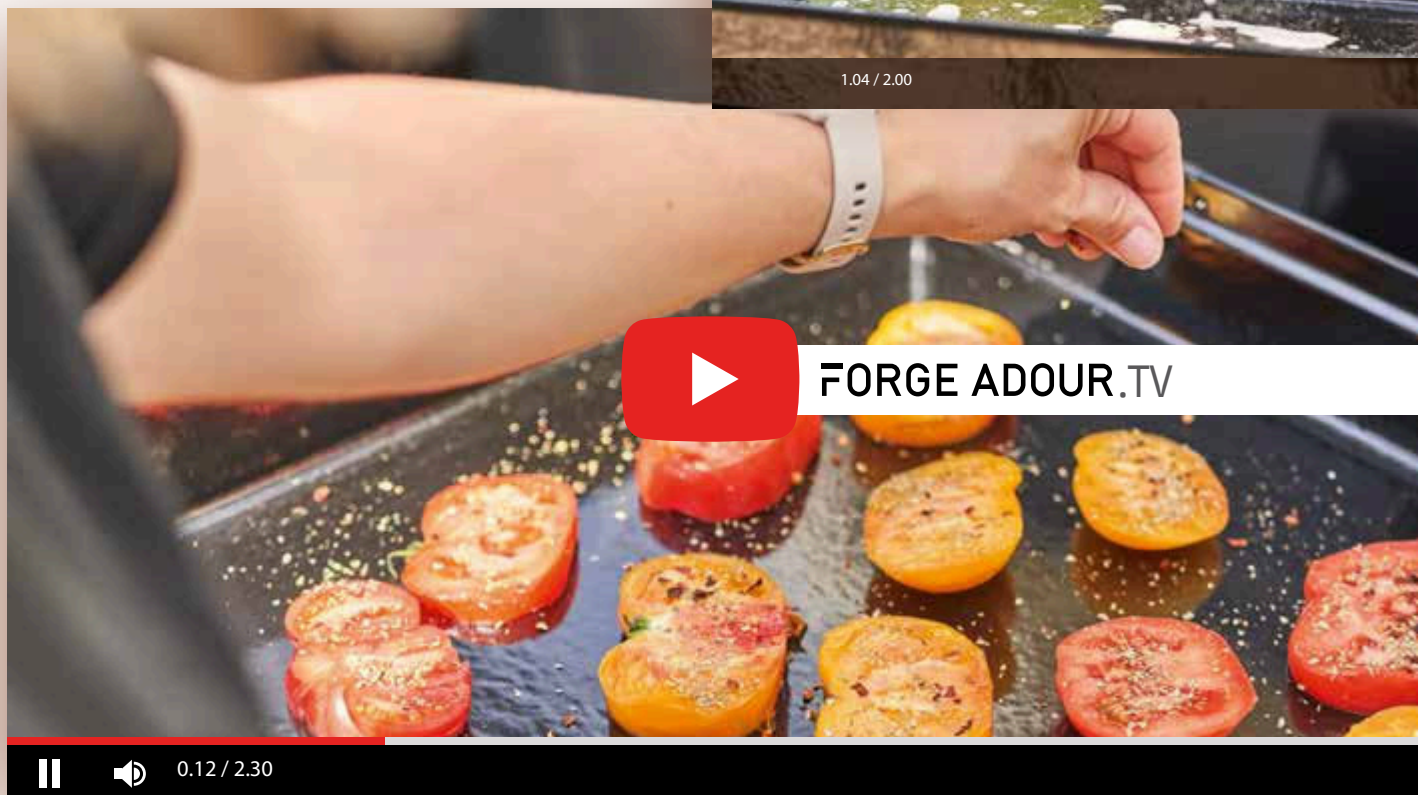



DESCUBRA TODOS NUESTROS CONSEJOS Y TUTORIALES

- Ayuda para el montaje
- Consejos de limpieza y mantenimiento
- Inspiración y cocina

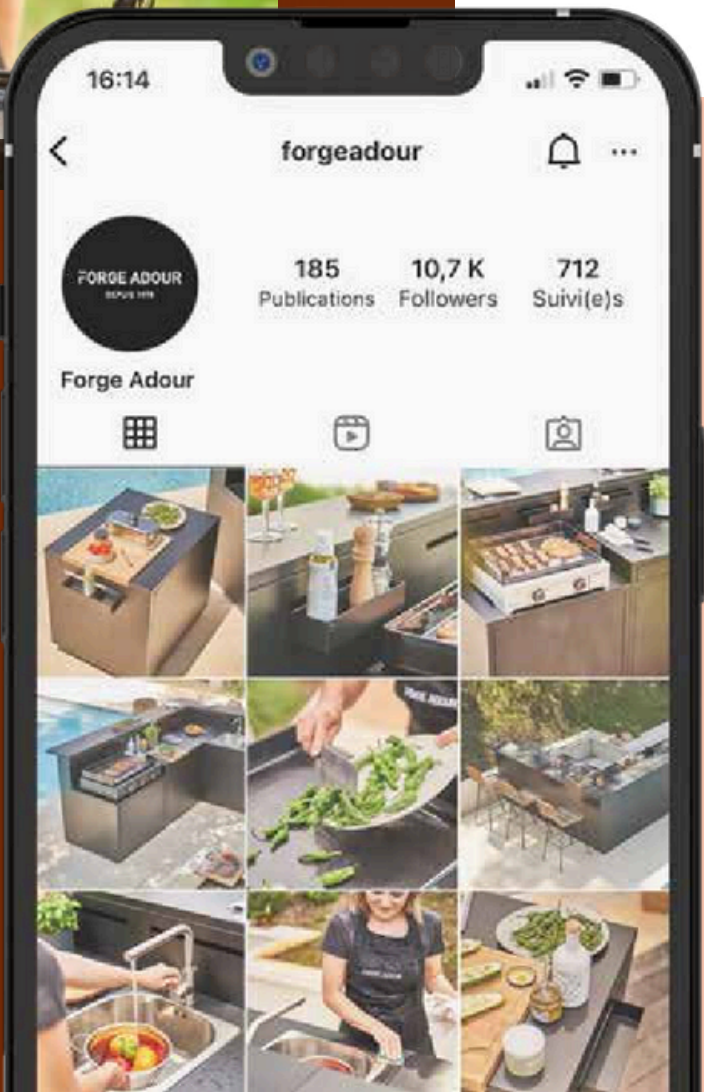

Le damos la bienvenida a la comunidad de Forge Adour

Un círculo abierto a todos los hedonistas, para intercambiar recetas, compartir experiencias culinarias y recibir las últimas noticias de Forge Adour.

Toda la **FELICIDAD** para experimentar

Planchas, cocinas exteriores, utensilios
y accesorios de cocina...
Forge Adour ofrece una amplia gama
de soluciones culinarias para todos los gustos.

NUESTRA GAMA

- PLANCHAS _____ ■ *Página 24*
- COCINAS EXTERIORES _____ ■ *Página 68*
- PARRILLAS _____ ■ *Página 78*
- ACCESORIOS Y UTENSILIOS _____ ■ *Página 82*



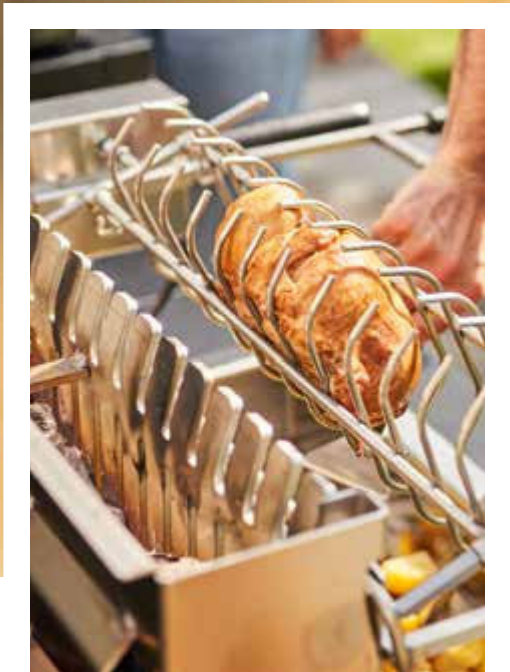

Series de PLANCHAS

— *Planchas* PARA UNA FELICIDAD DURADERA

- **Resistencia** a la corrosión, a los rayos UV y a los impactos
- Revestimiento **sin disolventes** con la etiqueta Smart Certified de categoría Platinum
- **Garantía** integral hasta 15 años
- **Reparables** al 100 %



+ INFORMACIÓN
SOBRE NUESTRAS PLANCHAS

Cómo elegir SU PLANCHA

- 1 ■ **Determine su ubicación**, interior o exterior
- 2 ■ **Defina la energía** que más le convenga
- 3 ■ **Elija el tamaño que se adapte** a su uso



Serie PREMIUM
Excelencia sin igual.
Una plancha excepcional.



Serie MODERN
Rendimiento con elegancia.
Un diseño definitivo.



Serie ORIGIN
Potencia y dominio.
El arte de la plancha.



Serie BASE
Sencillez y practicidad.
La esencia de la plancha.



Serie COOKING
La más ágil.
La plancha para todos los gustos.



Serie COMBI
Una unión perfecta.
Combinación única de parrilla
y plancha.





Excelencia sin igual. Una plancha excepcional.

La más refinada y con nuevas funciones, esta serie ofrece una facilidad de uso inigualable.

Serie
PREMIUM



- Doble pared de combustión acoplada con quemadores de diseño registrado para la plancha
- Mejor distribución y retención del calor, lo que supone un ahorro energético del 30 % (en comparación con las gamas anteriores)
- Placa de fundición esmaltada fabricada con una media del 80 % de materiales reciclados
- Espesor de placa optimizado para una mejor conservación y distribución del calor

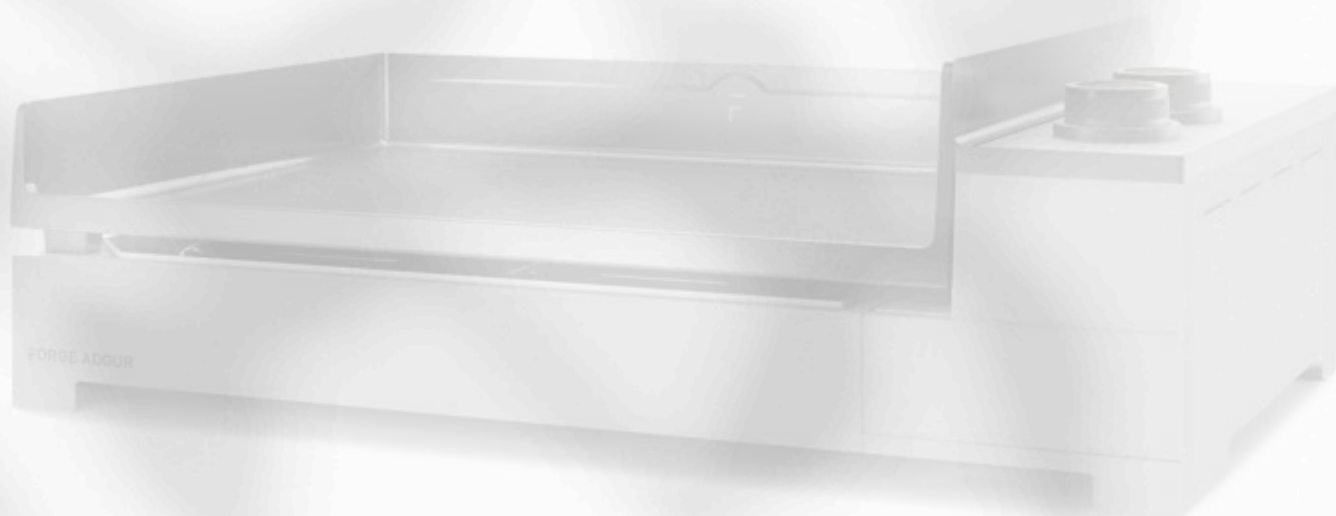

Serie
PREMIUM



Descubra
la serie

PLANCHAS

Información técnica



ELÉCTRICAS



GAS



INTERIOR



EXTERIOR



DISEÑO
ECOLÓGICO



GARANTÍA

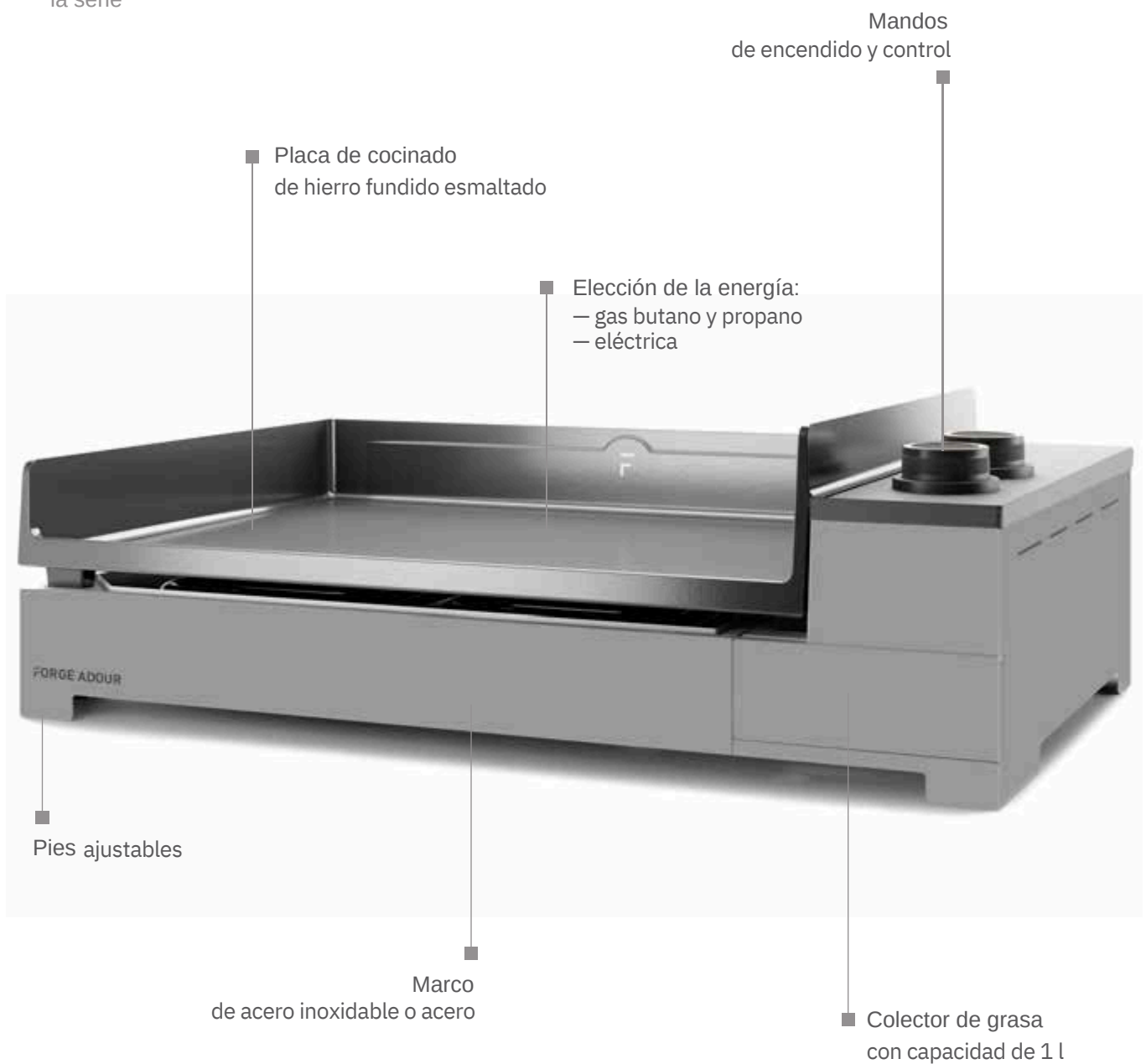



Serie
PREMIUM



DISEÑO ECOLÓGICO







PLANCHAS

MODELO 45 De 4 a 6 



PREMIUM E45 A NG
Marco de acero negro y gris claro







 l. 603 × an. 441 × al. 241 mm
Revestimiento de 3 capas
 31 kg
 2500 W
 8436550257168



PREMIUM E45 I
Marco de acero inoxidable



 l. 603 × an. 441 × al. 241 mm
 31 kg
 2500 W
 8436550202205









MODELO 60 De 8 a 10



PREMIUM E60 A NG
Marco de acero negro y gris claro







 l. 753 × an. 441 × al. 241 mm
Revestimiento de 3 capas
 36 kg
 3200 W
 8436550257151



PREMIUM E60 I
Marco de acero inoxidable







 l. 753 × an. 441 × al. 241 mm
 36 kg
 3200 W
 8436550202212



PREMIUM G60 A NG
Marco de acero negro y gris claro







 l. 753 × an. 463 × al. 241 mm
Marco de doble pared
Revestimiento de 3 capas
 34 kg
 2 = 5300 W
 8436550203349



PREMIUM G60 I
Marco de acero inoxidable







 l. 753 × an. 463 × al. 241 mm
Marco de doble pared
 34 kg
 2 = 5300 W
 8436550204476

MODELO 75 De 10 a 15



PREMIUM G75 A NG
Marco de acero negro y gris claro





 l. 903 × an. 463 × al. 241 mm
Marco de doble pared
Revestimiento de 3 capas
 39 kg
 3 = 6600 W
 8436550203998



PREMIUM G75 I
Marco de acero inoxidable



 l. 903 × an. 463 × al. 241 mm
Marco de doble pared
 39 kg
 3 = 6600 W
 8436550204490



- Repisas abatibles equipadas con gatos hidráulicos
- Cajón de almacenamiento de apertura rápida
- Ruedas giratorias
- Almacenamiento de botellas de gas

SMerOieD
PREMIUM



CARROS



DISEÑO ECOLÓGICO



MODELO 60



CHPAF 60 NG

Marco de acero negro
y gris claro

Plancha no incluida

↗ l. 875/1745* × an. 556 × al. 1042 mm
Revestimiento de 3 capas

👤 55 kg

📊 8436550201918

* dimensiones: cerrado/abierto



CHPIF 60

Marco de acero
inoxidable

Plancha no incluida

↗ l. 875/1745* × an. 556 × al. 1042 mm

👤 52 kg

📊 8436550204551

* dimensiones: cerrado/abierto

MODELO 75



CHPAF 75 NG

Marco de acero negro y
gris claro

Plancha no incluida

↗ l. 1025/1895* × an. 556 × al. 1042 mm
Revestimiento de 3 capas

👤 60 kg

📊 8436550201758

* dimensiones: cerrado/abierto



CHPIF 75

Marco de acero
inoxidable

Plancha no incluida

↗ l. 1025/1895* × an. 556 × al. 1042 mm

👤 59 kg

📊 8436550204568

* dimensiones: cerrado/abierto

Serie
MPROEDN



TAPAS



DISEÑO ECOLÓGICO



MODELO 60



CPIP 60 Acero inoxidable

- Tapa para planchas 60
- Compatible con módulos TRA, TRCAF N, SPAF CBN, SC CBN y DRPAF N

8436550205077



CPAP C 60 NG Acero negro y gris claro

- Tapa para carro Premium: CHPAF 60 NG
- Revestimiento de 3 capas

8436550204926



CPIP C 60 Acero inoxidable

- Tapa para carro Premium: CHPIF 60

8436550204957

MODELO 75



CPIP 75 Acero inoxidable

- Tapa para planchas 75
- Compatible con TRA, TRCAF N, SC CBN

8436550205084



CPAP C 75 NG Acero negro y gris claro

- Tapa para carro Premium: CHPAF 75 NG
- Revestimiento de 3 capas

8436550204933



CPIP C 75 Acero inoxidable

- Tapa para carro Premium: CHPIF 75

8436550204964

Serie
PREMIUM



CUBIERTAS



Cubierta
PLANCHA

MODELO 45

H 620 para plancha

8436550203080



Cubierta
CARRO

MODELO 60

H 770 para plancha

8436550203127

No compatible con CPIP 60

H 890 para carro*

8436550203158

MODELO 75

H 920 para plancha

8436550203165

No compatible con CPIP 75

H 1030 para carro*

8436550203004

* Colocar con las repisas abatidas





Rendimiento con elegancia. Un diseño definitivo.

Esta plancha ofrece el equilibrio perfecto entre rendimiento, innovación, cocina sana y diseño.

Serie
MODERN

M

- Doble pared de combustión acoplada con quemadores de diseño registrado para la plancha
- Mejor distribución y retención del calor, lo que supone un ahorro energético del 30 % (en comparación con las gamas anteriores)
- Placa de fundición esmaltada fabricada con una media del 80 % de materiales reciclados
- Espesor de placa optimizado para una mejor conservación y distribución del calor



Serie
MODERN

M



Descubra
la serie

PLANCHAS

Información técnica



ELÉCTRICAS



GAS



INTERIOR



EXTERIOR



DISEÑO
ECOLÓGICO



GARANTÍA

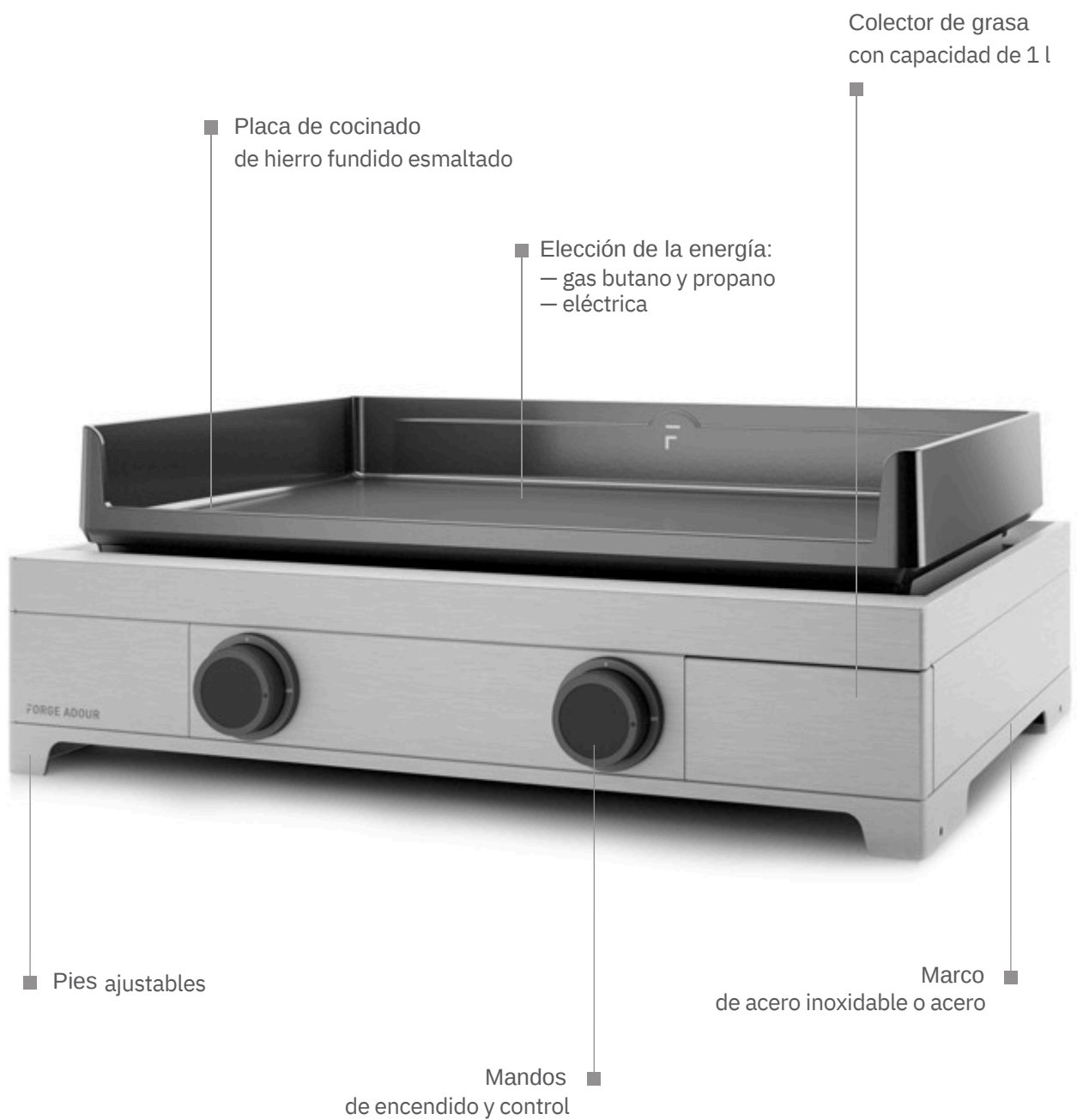



Serie
MODERN



PLANCHAS



DISEÑO ECOLÓGICO







MODELO 45 De 4 a 6 



MODERN E45 A N
Marco de acero negro



 l. 505 × an. 573 × al. 238 mm
Revestimiento de 3 capas



 28 kg
 2500 W
 8436550256628



MODERN E45 I
Marco de acero inoxidable



 l. 505 × an. 573 × al. 238 mm



 28 kg
 2500 W
 8436550202229



MODERN G45 A N
Marco de acero negro



 l. 505 × an. 573 × al. 238 mm
Marco de doble pared
Revestimiento de 3 capas

 27 kg
 1 = 3200 W
 8436550256666









MODELO 60 De 8 a 10



MODERN E60 A N
Marco de acero negro



 l. 655 × an. 573 × al. 238 mm
Revestimiento de 3 capas



 32 kg
 3200 W
 8436550256604



MODERN E60 I
Marco de acero inoxidable



 l. 655 × an. 573 × al. 238 mm



 32 kg
 3200 W
 8436550202236



MODERN G60 A N
Marco de acero negro



 l. 655 × an. 573 × al. 238 mm
Marco de doble pared
Revestimiento de 3 capas



 35 kg
 2 = 5300 W
 8436550256680



MODERN G60 I
Marco de acero inoxidable



 l. 655 × an. 573 × al. 238 mm
Marco de doble pared

 35 kg
 2 = 5300 W
 8436550204650

MODELO 75 De 10 a 15



MODERN G75 A N
Marco de acero negro



↗ I. 805 × an. 573 × al. 238 mm
Marco de doble pared
Revestimiento de 3 capas
⚖ 39 kg
🔥 3 = 6000 W
📊 8436550256642



MODERN G75 I
Marco de acero inoxidable



↗ I. 805 × an. 573 × al. 238 mm
Marco de doble pared
⚖ 39 kg
🔥 3 = 6000 W
📊 8436550204674



Serie
MODERN

M

CARROS



DISEÑO ECOLÓGICO



MODELO 45



CHMAF 45 N

Marco de acero negro Plancha no incluida

↗ I. 602/1473* × an. 573 × al. 987 mm
Revestimiento de 3 capas

👤 36 kg

📊 8436550256581

* dimensiones: cerrado/abierto

MODELO 60



CHMAF 60 N

Marco de acero negro Plancha no incluida

↗ I. 752/1623* × an. 573 × al. 987 mm
Revestimiento de 3 capas

👤 40 kg

📊 8436550257144

* dimensiones: cerrado/abierto



CHMIF 60

Marco de acero inoxidable Plancha no incluida

↗ I. 752/1623* × an. 573 × al. 987 mm
39 kg

📊 8436550202465

* dimensiones: cerrado/abierto

MODELO 75



CHMAF 75 N

Marco de acero negro Plancha no incluida

↗ I. 902/1773* × an. 573 × al. 987 mm
Revestimiento de 3 capas

👤 43 kg

📊 8436550257083

* dimensiones: cerrado/abierto



CHMIF 75

Marco de acero inoxidable Plancha no incluida

↗ I. 902/1773* × an. 573 × al. 987 mm

👤 43 kg

📊 8436550202472

* dimensiones: cerrado/abierto

Serie
MODERN



TAPAS



MODELO 45



CPAM C 45 Acero negro

Tapa abatible
Revestimiento de 3 capas

 Compatible con CHMAF 45, TRA, TRCAF N, SPAF CBN, SC CBN y DRPAF N

 8436550205381

MODELO 60



CPAM C 60 Acero negro

Tapa abatible
Revestimiento de 3 capas

 Compatible con CHMAF 60 y TRA, TRCAF N, SPAF CBN, SC CBN y DRPAF N

 8436550205398



CPIM C 60 Acero inoxidable

Tapa abatible

 Compatible con CHMIF 60 y TRA, TRCAF N, SPAF CBN, SC CBN y DRPAF N

 8436550205367

MODELO 75



CPAM C 75 Acero negro

Tapa abatible
Revestimiento de 3 capas

 Compatible con CHMAF 75 y TRA, TRCAF N, SPAF CBN y SC CBN

 8436550205404



CPIM C 75 Acero inoxidable

Tapa abatible

 Compatible con CHMIF 75 y TRA, TRCAF N, SPAF CBN y SC CBN

 8436550205374

Serie
MODERN

M

CUBIERTAS

GARANTÍA
2 AÑO
SOBRE EL TOTAL
DEL PRODUCTO



Cubierta
PLANCHA

MODELO 45

H 470 para plancha

8436550203073

H 630 para carro*

8436550203097



Cubierta
CARRO

MODELO 60

H 680 para plancha

8436550203103

H 790 para carro*

8436550203134

MODELO 75

H 830 para plancha

8436550203141

H 940 para carro*

8436550203172

* Colocar con las repisas abatidas



- Tapas abatibles
- Repisas abatibles equipadas con gatos hidráulicos
- Ruedas giratorias
- Almacenamiento de botellas de gas



Potencia y dominio. El arte de la plancha.

Es el referente de Forge Adour. Combina potencia, dominio y rendimiento. Facilidad de manejo garantizada.

Serie
ORIGIN



Serie
ORIGIN



PLANCHAS

Información técnica



GAS



EXTERIOR



GARANTÍA



Descubra
la serie





Serie
ORIGIN



PLANCHAS







MODELO 45 De 4 a 6



ORIGIN G45 A
Marco de acero negro



 l. 487 × an. 553 × al. 244 mm
Marco de doble pared
Revestimiento de 3 capas

 20 kg
 1 = 4500 W
 8436550204698



MODELO 60 De 8 a 10



ORIGIN G60 A
Marco de acero negro



 l. 637 × an. 553 × al. 244 mm
Marco de doble pared
Revestimiento de 3 capas

 25 kg
 2 = 5800 W
 8436550204711



MODELO 75 De 10 a 15



ORIGIN G75 A
Marco de acero negro



 l. 797 × an. 553 × al. 244 mm
Marco de doble pared
Revestimiento de 3 capas

 33 kg
 3 = 7500 W
 8436550204735



CARROS, TAPAS Y CUBIERTAS



MODELO 45

MODELO 60

MODELO 75



CHOA 45

Marco de acero negro Plancha no incluida

↗ l. 682/1137* × an. 558 × al. 995 mm
Revestimiento de 3 capas

👤 10 kg
8436550202489

* dimensiones: cerrado/abierto

CHOA 60

Marco de acero negro Plancha no incluida

↗ l. 832/1287* × an. 558 × al. 995 mm
Revestimiento de 3 capas

👤 11 kg
8436550202496

* dimensiones: cerrado/abierto

CHOA 75

Marco de acero negro Plancha no incluida

↗ l. 992/1447* × an. 558 × al. 995 mm
Revestimiento de 3 capas

👤 12 kg
8436550202502

* dimensiones: cerrado/abierto



Revestimiento de 3 capas
Compatible con TRA, DRPAF N

CPAO 45 Acero negro
8436550202748

CPAO 60 Acero negro
8436550202755

CPAO 75 Acero negro
8436550202762



Cubierta
PLANCHA

H 470 para plancha ORIGIN 45
8436550203073

H 680 para plancha ORIGIN 60
8436550203103

H 830 para plancha ORIGIN 60
8436550203141



Cubierta
CARRO

H 730 para carro ORIGIN 45
8436550203110

H 890 para carro ORIGIN 60
8436550203158

H 1030 para carro ORIGIN 75
8436550203004



Sencillez y practicidad.
La esencia de la plancha.

Esta plancha es imprescindible cuando se trata de facilidad de uso. Tiene todo lo esencial de una plancha, con opción de placa de cocinado de hierro fundido esmaltado o de acero inoxidable.

Serie
BASE

B
I



Serie
BASE

B



Descubra
la serie

PLANCHAS

Información técnica



ELÉCTRICAS



GAS



INTERIOR



EXTERIOR



GARANTÍA

GARANTÍA
5 AÑOS
SOBRE EL TOTAL
DEL PRODUCTO

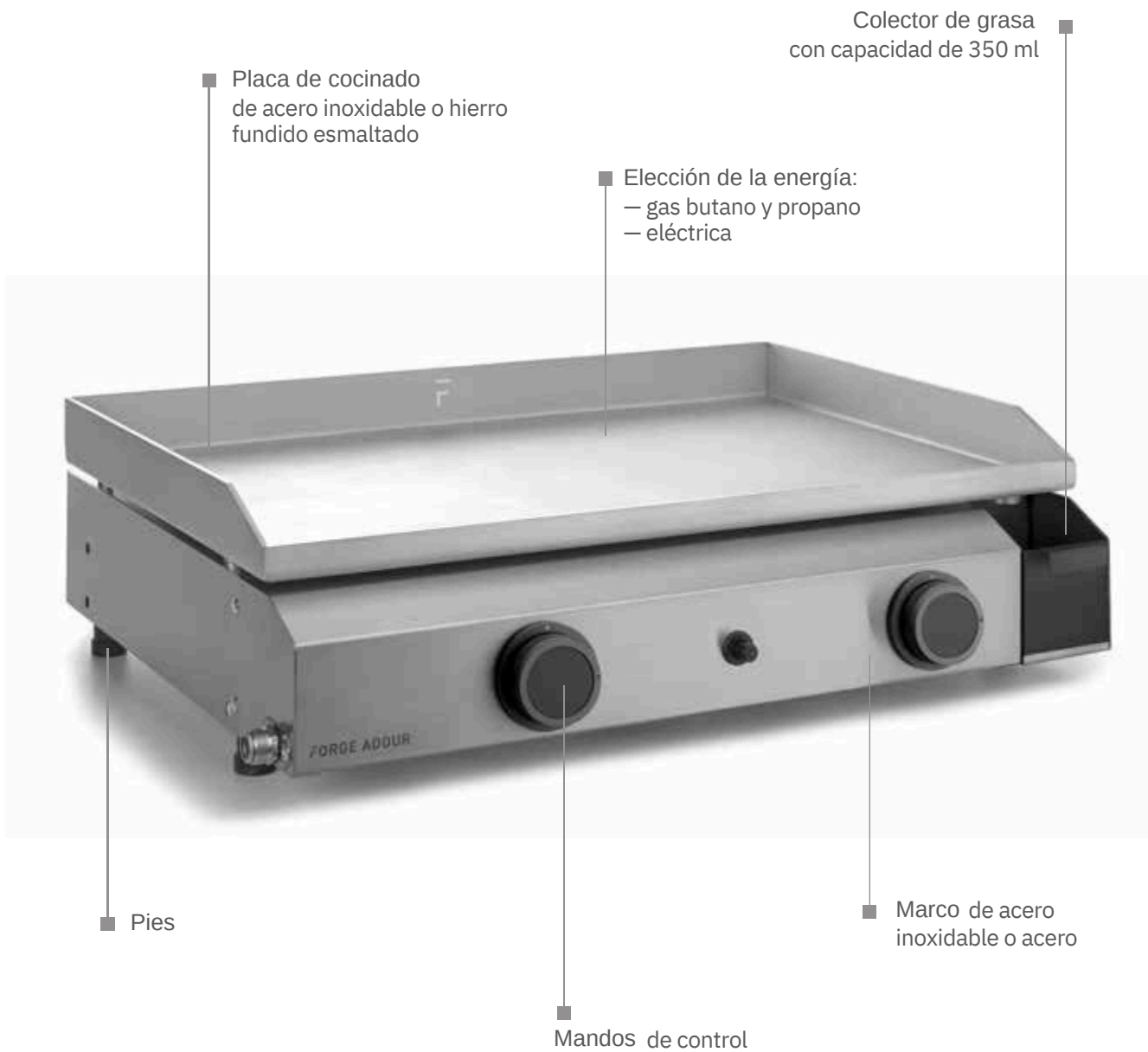



Serie
BASE

B

PLANCHAS



MODELO 45 De 4 a 6



BASE G45 A
Marco de acero negro



l. 432 × an. 478 × al. 194 mm
Revestimiento de 3 capas
 13 kg
 1 = 2700 W
 8436550204810

MODELO 60 De 8 a 10



BASE E60 I
Marco de acero inoxidable



l. 632 × an. 478 × al. 194 mm
Placa de cocinado de acero inoxidable
 20 kg
 3200 W
 8436550257120



BASE G60 I
Marco de acero inoxidable



l. 632 × an. 478 × al. 194 mm
Placa de cocinado de acero inoxidable
 20 kg
 2 = 5800 W
 8436550204872



BASE G60 A
Marco de acero negro



l. 632 × an. 478 × al. 194 mm
Revestimiento de 3 capas
 20 kg
 2 = 5000 W
 8436550204834

CARRO Y CUBIERTAS



CHBA 60

Marco de acero negro Plancha no incluida

↗ l. 1194 × an. 480 × al. 857 mm
Revestimiento de 3 capas

👤 10 kg
▮▮▮▮ 8436550202526



H 470 para plancha BASE 45

▮▮▮▮ 8436550203073

H 680 para plancha BASE 60

▮▮▮▮ 8436550203103



H 1220 para carro BASE 60

▮▮▮▮ 8436550203011



La más ágil.

La plancha para todos los gustos.

Esta gama ha sido diseñada para alargar el verano y puede adaptarse tanto a interiores como a exteriores. Una plancha táctil fácil de usar para un cocinado más preciso.

Serie
COOKING



Serie
COOKING



Descubra
la serie

PLANCHAS

Información técnica



ELÉCTRICAS



INTERIOR



EXTERIOR



GARANTÍA



Tapa integrada
abatible

Placa de cocinado
de hierro fundido esmaltado

Energía eléctrica

Marco de acero

Pantalla de control táctil

Colector de grasa
con capacidad de 300 ml

PLANCHA Y CUBIERTA



MODELO 45 De 4 a 6 



COOKING

Marco de acero negro

 l. 365 × an. 555/625* × al. 145/515* mm
Revestimiento de 3 capas

 18 kg

 2500 W

 8436550257113

* dimensiones: cerrado/abierto



H 350 para la plancha COOKING

 8436550257106



Una unión perfecta. Combinación única de parrilla y plancha.

Dos en uno, la unión de la plancha y la parrilla. Dos métodos de cocinado complementarios en los que la mezcla de sabores del cocinado a la parrilla y del incomparable sabor del fuego de leña sorprenderán a más de uno.

Serie
COMBI



Serie
COMBI



PLANCHAS

Información técnica



GAS



CARBÓN
VEGETAL



EXTERIOR



GARANTÍA



Descubra
la serie

Tapas
de protección

Parrilla de acero inoxidable
con 3 alturas

Placa de cocinado
de hierro fundido esmaltado

Mandos de control

Colector de grasa
con capacidad de 1,2 l

Marco de acero

Colector de ceniza
integrado







PLANCHA & PARRILLA



MODELO COMBI De 15 a 20 



COMBI G NG
Combi plancha/parrilla
Marco de acero negro
y gris claro

 l. 1500 × an. 600 × al. 238 mm

Marco de doble pared para el juego de plancha
Revestimiento de 3 capas

 82 kg

 2 = 6000 W

 Carbón vegetal

 8436550256109



CARRO Y CUBIERTAS



TRAFCO NG

Módulo para
COMBI G NG

Marco de acero negro
y gris claro

↗ l. 1500/2230* × an. 600 × al. 990 mm
Revestimiento de 3 capas

👤 98 kg

📊 8436550203653

COMBI G NG no incluido

* dimensiones: cerrado/abierto



H 1520

para COMBI G NG

📊 8436550203059



H 1570

para TRAFCO NG y COMBI G NG

📊 8436550203066

COCCINAS

exteriores

— *Muebles de cocina* PARA LA FELICIDAD A GRAN ESCALA

Ya se trate de un módulo para plancha, una encimera, una mesa con ruedas, un módulo auxiliar o un fregadero, todos nuestros muebles de cocina son modulares, para que pueda crear la cocina perfecta para disfrutar.

- **Compatibles** con todas nuestras planchas
- **Garantía** de 2 años
- 100 % **modular**
- Zona de **barra integrada**



DISEÑE
SU COCINA EXTERIOR

Novedad de 2024

Todos nuestros muebles incluyen una zona de barra para **compartir** aún más momentos de placer.



iTome inspiración!

Ejemplos
de configuraciones



COMPACTA

1 módulo: módulo de cocina



FUNCIONAL

3 módulos: módulo de plancha +
+ módulo auxiliar + módulo de fregadero



PRÁCTICA

2 módulos: módulo de plancha
+ módulo auxiliar





CÓMODA

4 módulos: módulo de plancha
+ módulo auxiliar
+ módulo de esquina
+ módulo de fregadero



COMPLETA

5 módulos: módulo de plancha
+ módulo auxiliar
+ módulo de esquina
+ módulo de fregadero
+ módulo de parrilla

Diseñe su cocina exterior

ELIGIENDO MÓDULOS

MÓDULOS



Módulo de plancha
SPAF CBN - 8436555025700



Módulo auxiliar
SDAF CBN - 8436555025748



Módulo de fregadero
SEAF CBN - 8436555025717



Módulo de esquina
SAAF CBN - 8436555025755



Módulo de cocina
SC CBN - 8436555025892



Módulo de parrilla
SGAF 66 CBN - 8436555025731

Opciones:



Regletas Juego de 2
8436555025809



Bandeja de almacenamiento
8436555025793

MESA AUXILIAR



Mesa auxiliar con ruedas
DRPAFN - 8436555025687

MESAS CON RUEDAS

Mesas con ruedas

TRAFN - 84365550256505

TRANG - 84365550202564



Mesa con ruedas con aparador cerrado
TRCAF N - 8436555025694

COCINAS exteriores



Información técnica



■ Zona de barra
Opcional: 2 regletas

Almacenamiento de botellas de gas
puerta con apertura rápida

■ Bandeja de almacenamiento
1 bandeja integrada por
módulo + opcional

■ Cajón de almacenamiento
de apertura rápida



■ Esquina

■ Fregadero y grifo de acero inoxidable

■ Almacenamiento puerta con apertura rápida



■ Almacenamiento puerta con apertura rápida

■ Pies ajustables

MÓDULOS AUXILIARES



MÓDULO DE PLANCHA



SPAF CBN
Zona de barra negra de acero
cerrada

- Compatible con planchas 45, 60, 75
- I. 900 × an. 972 × al. 1125 mm
- Revestimiento de 3 capas
- Puerta con apertura rápida
- Bandeja de almacenamiento
- 64 kg
- 8436555025700

MÓDULO AUXILIAR



SDAF CBN
Zona de barra negra de acero
cerrada

+ Posibilidad de insertar un
frigorífico de 46 l

- I. 900 × an. 972 × al. 1125 mm
- Revestimiento de 3 capas
- Cajón y puerta de apertura rápida
- Repisa interior
- Bandeja de almacenamiento
- 81 kg
- 8436555025748

MÓDULO DE FREGADERO



SEAF CBN
Zona de barra negra de acero
cerrada

+ Conexión de manguera

- I. 900 × an. 972 × al. 1125 mm
- Revestimiento de 3 capas
- Puerta con apertura rápida
- Bandeja de almacenamiento
- 71 kg
- 8436555025717

MÓDULO DE ESQUINA



SAAF CBN

Zona de barra negra de acero cerrada

⊕ Permite crear una esquina a la izquierda o a la derecha

↗ l. 972 × an. 972 × al. 1115 mm
Revestimiento de 3 capas
Bandeja de almacenamiento

⚖ 50 kg
8436555025755

MÓDULO DE COCINA



SC CBN

Zona de barra negra

↗ l. 1200 × an. 972 × al. 1125 mm
Revestimiento de 3 capas
2 cajones y 2 puertas de apertura rápida
Bandeja de almacenamiento

⚖ 99 kg
8436555025892

MÓDULO DE PARRILLA



SGAF CBN

Zona de barra negra de acero cerrada

⊕ Permite incorporar una parrilla 66

↗ Compatible con parrillas*: 961.66 y 918.66
↗ l. 900 × an. 972 × al. 1125 mm
Revestimiento de 3 capas
Puerta con apertura rápida

⚖ 59 kg
8436555025731

* Parrillas no incluidas

MESA AUXILIAR CON RUEDAS



DRPAF N

Acero negro cerrada

↗ Compatible con planchas 45, 60, 75
Excepto plancha Premium 75, CPIP 60 y 75
↗ l. 810/890* × an. 630 × al. 740 mm
Revestimiento de 3 capas
Bandeja de almacenamiento
4 ruedas giratorias con 2 frenos

⚖ 27 kg
8436555025687

* dimensiones: sin/con bandeja de almacenamiento

MESAS CON RUEDAS



TRA N

Mesa de acero negro con ruedas

↗ l. 1191 × an. 640 × al. 760 mm

Revestimiento de 3 capas

👤 28 kg

📊 8436550256505



TRA NG

Mesa de acero negro y gris claro con ruedas

↗ l. 1191 × an. 640 × al. 760 mm

Revestimiento de 3 capas

👤 28 kg

📊 8436550202564



TRCAF N

Mesa de acero negro con aparador cerrado y con ruedas

↗ l. 1200/1640* × an. 657 × al. 1125 mm

Revestimiento de 3 capas

Repisa lateral izquierda o derecha

Puertas con apertura rápida

👤 57 kg

📊 8436555025694

* dimensiones: repisa lateral cerrada/abierta





CUBIERTAS



H 930

Cubierta para módulos de plancha, auxiliares, de fregadero y de parrilla
SPAF CBN, SDAF CBN, SEAF CBN, SGAF CBN

8436555025779



H 850

Cubierta para módulo auxiliar
DRPAF N

8436555025762



H 1220

Cubierta para mesas con ruedas
TRA N, TRA NG

8436550203011

H 1230

Cubierta para mesa con ruedas, con aparador cerrado de acero
TRCAF N

8436550203028

Serie PARRILLAS

— ■ *Independientes o empotradas*
A CADA CUAL SU COCINA.

Cocinar es una cuestión personal y de sensibilidad, por eso nuestros diseñadores también le han puesto ganas al diseño de nuestras parrillas.

- Auténtica cocina con **carbón vegetal**
- **Garantía** de 2 años
- Parrillas 66 compatibles con el módulo **SGAF CBN**



DESCUBRA
TODA LA SERIE DE PARRILLAS

Simple
O DOBLE

Nuestras parrillas están disponibles con un único fuego horizontal o con un doble fuego horizontal y vertical **para disfrutar aún más.**



PARRILLAS

Empotradas o independientes



EXTERIOR



CARBÓN VEGETAL



FUEGO HORIZONTAL



961.56

Parrilla de acero inoxidable empotrada o independiente

Ascuador horizontal

Brochetas de acero inoxidable: 8

Parrilla ajustable de acero inoxidable: 1

Marco: l. 560 × an. 455 × al. 470 mm

Reserva incorporada: 510 × 425 mm

21 kg

8436550256307



961.66

Parrilla de acero inoxidable empotrada o independiente

Ascuador horizontal

Brochetas de acero inoxidable: 8

Parrilla ajustable de acero inoxidable: 1

Marco: l. 660 × an. 455 × al. 470 mm

Reserva incorporada: 610 × 425 mm

25 kg

8436550256314





FUEGO HORIZONTAL Y VERTICAL

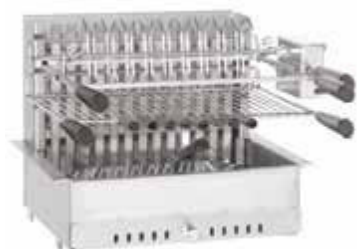

918.56

Parrilla de acero inoxidable empotrada o independiente

Ascuador horizontal y vertical
 Espetón eléctrico ajustable
 Bandeja recoge grasas con asa
 Brochetas de acero inoxidable: 8
 Parrilla ajustable de acero inoxidable: 1

Marco: l. 560 × an. 435 × al. 475 mm
 Reserva incorporada: 510 × 425 mm

34 kg
 8436550256321

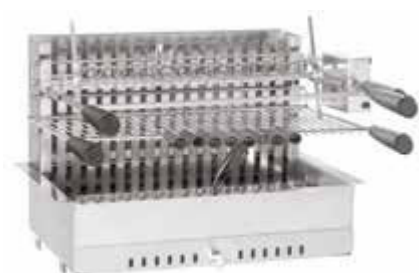

918.66

Parrilla de acero inoxidable empotrada o independiente

Ascuador horizontal y vertical
 Espetón eléctrico ajustable
 Bandeja recoge grasas con asa
 Brochetas de acero inoxidable: 8
 Parrilla ajustable de acero inoxidable: 1

Marco: l. 660 × an. 435 × al. 475 mm
 Reserva incorporada: 610 × 425 mm

40 kg
 8436550256338



ACCESORIOS y utensilios

— *Para ampliar la experiencia*
CON NUESTROS ACCESORIOS Y UTENSILIOS
DISEÑADOS PARA LA PLANCHA

Empezar bien a cocinar a la plancha

Utensilios de cocina

Productos de limpieza

Productos con diseño ecológico

Compatibles con todas nuestras planchas



INFORMACIÓN
SOBRE NUESTROS ACCESORIOS

Empiece
A COCINAR

Contar con el equipo adecuado para empezar a cocinar y mantener su plancha hace que la **experiencia sea aún mejor.**



ACCESORIOS Y UTENSILIOS



PUESTA EN MARCHA



CODO PARA
GAS 90°
Codo para planchas de gas

||||| 8437013651622



UTENSILIOS DE COCINA



ESPÁTULA CORTA DE POLIOXIMETILENO CON ÁNGULO

5413821019765



ESPÁTULA CORTA CON ÁNGULO DE ACERO INOXIDABLE

5413828500389



ESPÁTULA LARGA DE POLIOXIMETILENO

8436550200386



ESPÁTULA GRANDE DE POLIOXIMETILENO

8436550200263



RASQUETA DE POLIOXIMETILENO

5413821019789



PINZA DE POLIOXIMETILENO

5413821019802



PINZA CORTA DE ACERO INOXIDABLE

5413828500419



TRINCHADOR CORTO DE POLIOXIMETILENO

5413821019826



CAMPANA DE COCCIÓN DE ACERO INOXIDABLE Ø28

8437010175145



REJILLA DE ACERO INOXIDABLE Ø25

8436550200294



PROTECTOR DE SALPICADURAS

8436550200249



TABLA DE CORTAR DE BAMBÚ CON TOPE

8436550200393



DELANTAL DE COCINA

8437010174476



ESTUCHE DE 3 UTENSILIOS DE POLIOXIMETILENO

5413821019741

ACCESORIOS Y UTENSILIOS



Fuera de garantía: productos y utensilios de limpieza DISEÑO ECOLÓGICO

LIMPIEZA Y MANTENIMIENTO



PLANCHA NET
Limpiador ecológico
500 ml

8436550205312



KIT DE LIMPIEZA ABSORB

Espray Plancha Net 250 ml,
Net Absorb 500 ml y estropajo de
acero inoxidable

8436550257052



NET INOX
Limpiador ecológico
500 ml

8436550205343



NET ABSORB
500 ml

8436550257045



**ESTROPAJO DE
ACERO INOXIDABLE**

8437010175138



**PIEDRA
DE LIMPIEZA**

8437013651660

Limpie bien SU PLANCHA

1. Vierta agua limpia sobre la placa caliente y rasque los restos de cocción en el colector de grasa utilizando la espátula.
2. Frote la placa de hierro fundido con un estropajo de acero inoxidable y enjuague con agua.
3. Rocíe la placa fría con espray limpiador y límpiela con papel absorbente.
4. Vierta varias cucharadas de Net Absorb en el colector de grasa. Mezcle y deje actuar unos minutos. Vacíe el colector de grasa en el compost o en la basura.



+ **DESCUBRA**

NUESTROS VIDEOTUTORIALES SOBRE
LIMPIEZA Y MANTENIMIENTO



CARTA DE COLORES

CARTA DE COLORES DE ACABADO MATE

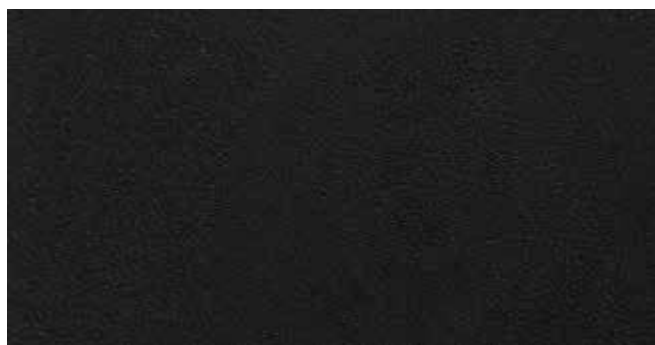

Negro
RAL 9005



Gris claro
RAL 9007

CARTA DE COLORES
DE ACABADO EN ACERO INOXIDABLE

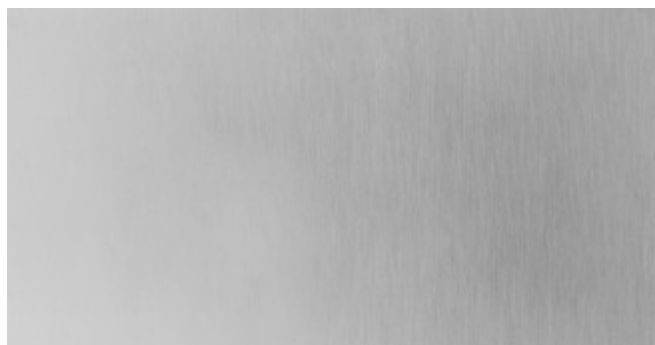

Acero inoxidable
satinado





FORGE ADOUR

Empresa comprometida con el reciclaje de productos y embalajes:

ecosystem
recycling clean packaging

ecomaison

CIITEO
D'annons ensemble une nouvelle vie à nos produits.

Re_fashion

screlec
emballés dans une économie circulaire

ECO DDS



FOTOS
Propagande - Maxime Vantorre
SOCIO COLABORADOR
La Maison Jean Vier
IMPRESIÓN Abéradère Impression

Catálogo en papel FSC
Impresora certificada Imprim'vert

IMPRIM'VERT®





FOTOS NO CONTRACTUALES

Este catálogo, todo su contenido y todos los derechos relacionados son propiedad exclusiva de FORGE ADOUR. Todos los modelos presentados (protegidos o no por derechos de diseño), textos, obras, ilustraciones, marcas e imágenes reproducidas están protegidos por las leyes de derechos de autor y de propiedad industrial en todo el mundo. Cualquier reproducción, total o parcial, de los modelos, del catálogo o de cualquiera de sus componentes está estrictamente prohibida sin el consentimiento previo por escrito de FORGE ADOUR. Cualquier infracción de las disposiciones de este artículo expondrá al infractor a procedimientos judiciales. Estos últimos incurrirán en responsabilidad civil y penal por actos de falsificación, competencia desleal o parasitismo.

