



Crafted to wonder

bellfires. gas fires

Crafted to wonder

- Wij begrijpen als geen ander wat een haard aan het leven kan toevoegen. Al sinds 1976 bieden wij de ultieme vuurbeleving. Met passie, hartverwarmend vakmanschap en oog voor detail maken wij in onze eigen fabriek in Nederland excellente gas- en houthaarden. Wij maken jouw haard met gevoel voor stijl; tijdloos of eigentijds. Er is keuze uit een breed assortiment modellen en oneindig veel mogelijke combinaties. Onze haarden zijn van hoge kwaliteit en werken veilig en probleemloos. Je kunt rekenen op een bijzonder goede service en vakkundige hulp bij het onderhoud van je haard. Laat je verwonderen door onze haarden, en maak momenten magisch. Staar in de vlammen en zweef naar andere gedachten.
- We understand better than anyone how much a fireplace can enrich your life. Since, 1976, we have been providing the ultimate fire experience. With passion, heart-warming craftsmanship and attention to detail, we manufacture outstanding gas and wood fires in our factory in the Netherlands. We create your fireplace with a sense of style: timeless or contemporary. The choice includes a wide range of models and infinite possible combinations. Our fires are high quality and work safely and problem-free. You can count on an exceptionally good service and professional help with maintaining your fireplace. Our fireplaces are made to wonder and create magical moments. Stare into the flames and let yourself relax.

- Nous savons mieux que quiconque comment un foyer peut enrichir la vie. C'est depuis 1976 déjà que nous offrons l'expérience ultime du feu. Avec passion, un savoir-faire incomparable et le souci du détail, nous fabriquons d'excellents appareils au gaz et au bois dans notre propre usine aux Pays-Bas. Nous fabriquons votre appareil avec le sens du style : intemporel ou contemporain. Il y a le choix entre un large assortiment de modèles, avec d'infinies possibilités de combinaison. Nos appareils sont de qualité supérieure et fonctionnent en toute sécurité et sans le moindre problème. Vous pouvez compter sur un service après-vente particulièrement efficace et sur une assistance spécialisée pour l'entretien de votre appareil. Laissez-vous surprendre par nos appareils, et rendez ces moments magiques. Fixez les flammes et évadez-vous vers d'autres pensées.
- Sappiamo meglio di chiunque altro quello che un camino può aggiungere alla tua vita. Dal 1976 offriamo un'esperienza del fuoco irripetibile. È con passione, maestria ed attenzione al dettaglio che creiamo nella nostra fabbrica nei Paesi Bassi camini a gas e a legna di qualità eccellente. Creiamo il vostro camino con amore per lo stile, sia che si tratti di un pezzo dallo stile senza tempo o al passo con i tempi moderni. Offriamo una vasta gamma di scelta tra svariati modelli e infinite possibilità di combinazioni. I nostri camini sono di alta qualità, sono affidabili e sicuri. Per la manutenzione del vostro camino potete contare su un'ottima assistenza e aiuto professionale. Lasciatevi sorprendere dai nostri camini e rendete ogni istante magico. Godetevi il gioco delle fiamme e rilassatevi.

belfires. gas fires



Overzicht uitvoeringen

Vue d'ensemble des versions | Overview of versions | Panoramica delle versioni

Original Bell serie

Derby⁽¹⁾ / Topsham⁽²⁾ / York⁽³⁾

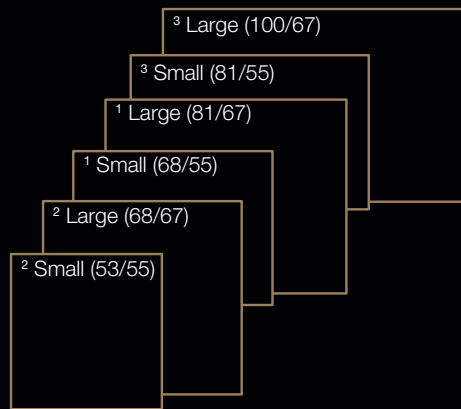

Classic Bell

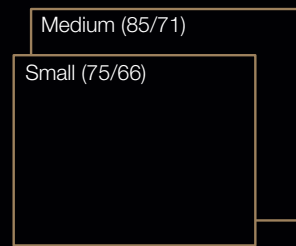

Horizon Bell

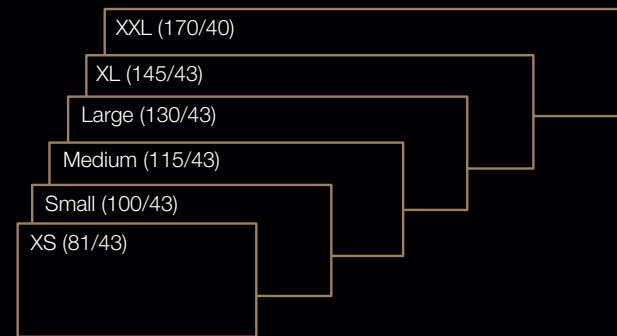

Vertical Bell

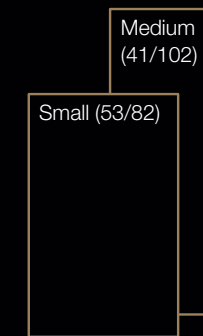

Smart Bell serie

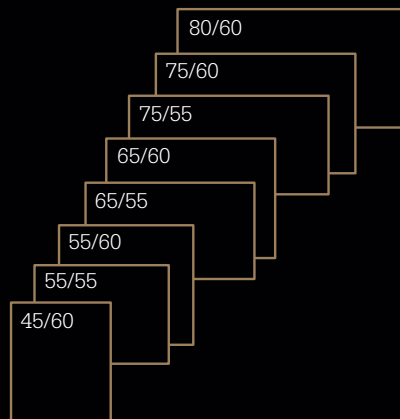

MagniFire

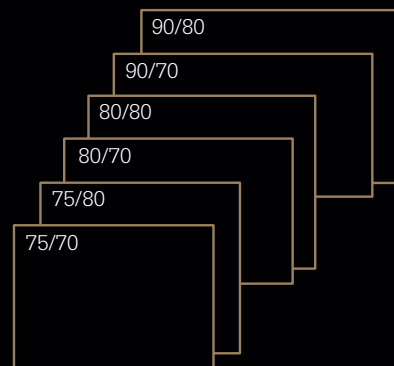

Premium Fire

Unica serie

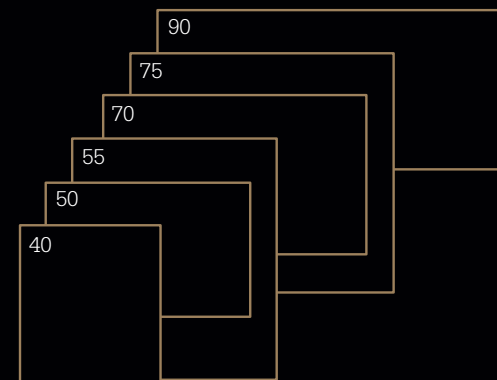

Topsham



Small



Large



ORIGINAL BELL
SERIE

P.108



P.118-121



P.123



P.124



P.126-129



P.117



P.117



P.116



P.36

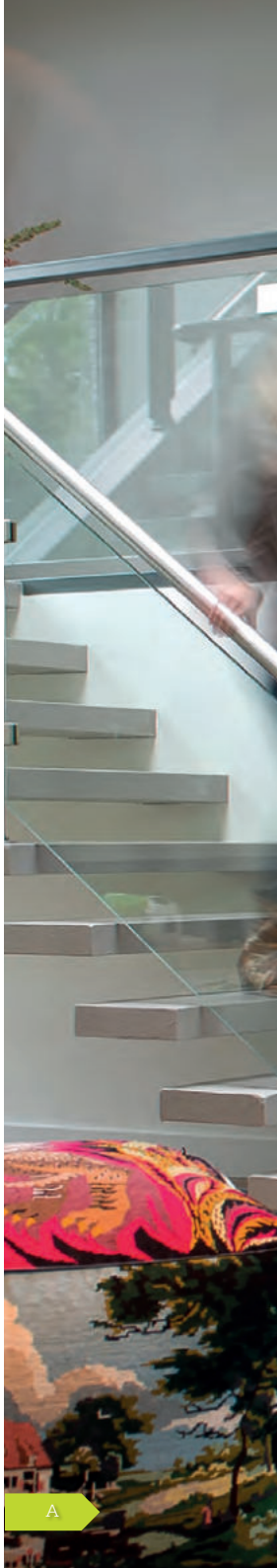

A



Derby



B

Kader: Hidden Door | Brander: Line Fire

ORIGINAL BELL
SERIE

P.108



P.118-121



P.123



P.124



P.126-129



P.117



P.117



P.116



P.36

A





York



ORIGINAL BELL
SERIE

P.108



P.118-121



P.123



P.124



P.126-129



P.117



P.117



P.116



P.36-37

Classic Bell



ORIGINAL BELL
SERIE

P.108



P.121



P.122



P.124



P.126-129



P.117



P.117



P.116



P.37

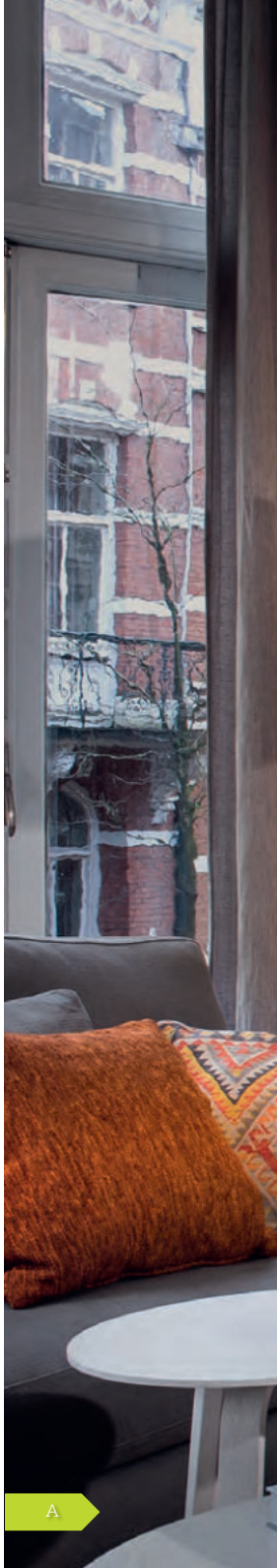

A



Horizon Bell



Kader: Floating Frame | Brander: Center Fire

ORIGINAL BELL
SERIE

P.108



P.118-119



P.123



P.124



P.126-129



P.117



P.117



P.116



P.37



Horizon Bell



ORIGINAL BELL
SERIE

P.108



P.118-119



P.123



P.124



P.126-129



P.117



P.117



P.116



P.38

Horizon Bell



A

Kader | Cadre | Frame | Cornice: Floating Frame
 Brander | Brûleur | Burner | Bruciatore: Line Fire

ORIGINAL BELL
 SERIE

P.108



P.118-119



P.123



P.124



P.126-129



P.117



P.117



P.116



P.38

B



Vertical Bell

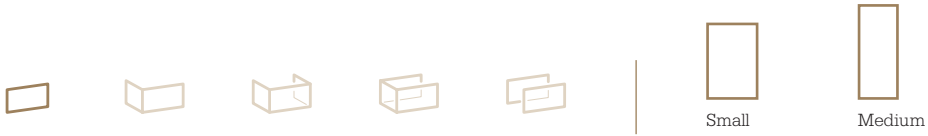

- ORIGINAL BELL SERIE
- P.108
 - LC
 - P.118-119
 - P.123
 - P.124
 - P.126-129
 - P.117
 - P.117
 - P.116
 - P.38-39



Smart Bell / Unica

Voor renovatiesituaties | Situations de rénovation | Renovation situations | In caso di ristrutturazioni

- De gashaarden op de volgende pagina's zijn met name geschikt voor bestaande situaties, waarbij een bestaande (open) haard of kachel vervangen wordt door een nieuwe gashaard. Dit worden ook wel renovatiesituaties genoemd. De Smart Bell en Unica noemt men vanwege deze toepassing ook wel inzethaarden. Door de maatvoering en kadervarianten zijn zij namelijk uitermate geschikt voor bijna elke bestaande situatie. Daarbij zijn deze gashaarden van binnenuit aan te sluiten op het aanwezige rookkanaal en is de techniek van binnenuit benaderbaar, er is dus geen inbouwluikje nodig. Uiteraard zijn de Smart Bell en Unica ook geschikt voor elke nieuwe situatie.
- Les appareils gaz des pages suivantes sont particulièrement adaptés aux situations existantes dans lesquelles un foyer ou un poêle existant (ouvert) est remplacé par un nouvel appareil gaz. Celles-ci sont également appelées situations de rénovation. C'est pourquoi, Smart Bell et Unica sont également appelés inserts. En raison de leurs dimensions et de leurs large gamme de tailles et de cadres, ils conviennent parfaitement à presque toutes les situations existantes. De plus, ces inserts gaz peuvent être connectés de l'intérieur au conduit de fumée existant et de ce fait, aucune trappe d'accès n'est requise. Les Smart Bell et Unica sont bien sûr également adaptés à chaque nouvelle situation.
- The gas fireplaces on the following pages are suitable for existing situations where an existing (open) fireplace or stove is replaced by a new gas fire. These are also called renovation situations. Due to this application, the Smart Bell and Unica are also called inserts. The dimensions and framework variants allow them to be extremely suitable for almost every existing situation. These gas fires can be connected from the inside to the existing flue and the electronics are all accessed from the inside, so no installation hatch is required. The Smart Bell and Unica are of course be built into new installation situations.
- I camini a gas nelle pagine seguenti sono particolarmente adatti per le situazioni esistenti in cui un caminetto o stufa esistente (aperto) viene sostituito da un nuovo apparecchio a gas. Queste sono anche chiamate situazioni di rinnovamento. Data questa possibilità di installazione, Smart Bell e Unica sono anche chiamati inserti. Grazie alla varietà di modelli e cornici disponibili, questi articoli sono estremamente adatti a quasi tutte le situazioni esistenti. Inoltre, questi apparecchi a gas possono essere alla canna fumaria esistente dall'interno e non è necessario un pannello di accesso esterno. Smart Bell e Unica sono ovviamente adatti anche per essere installati come caminetti in nuove installazioni.



Smart Bell



B

Kader: Verdiept kader 15 mm | Brander: MagniFire

SMART BELL
SERIE
P.113

MP
P.121

P.123

P.124

P.126-129

P.117

P.117

P.115

P.115

P.116



P.41

B



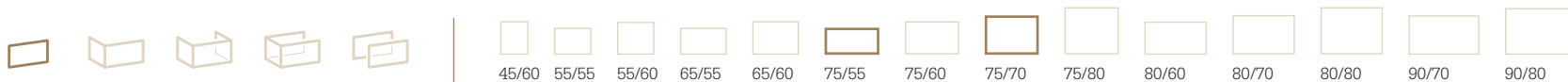

Smart Bell



SMART BELL
SERIE

P.113



P.120-121



P.123



P.124



P.126-129



P.117



P.117



P.115



P.115



P.116



P.41

Smart Bell



SMART BELL
SERIE

P.113



P.121



P.123



P.124



P.126-129



P.117



P.117



P.115



P.115



P.116



P.41

Smart Bell



SMART BELL
SERIE

P.113



P.121



P.123



P.124



P.126-129



P.117



P.117



P.115



P.115



P.116



P.41



Smart Bell



SMART BELL
SERIE

P.113



P.121



P.123



P.124



P.126-129



P.117



P.117



P.115



P.115



P.116



P.41



Unica



UNICA
SERIE

P.114



P.123



P.124



P.126-129



P.117



P.115



P.42





Unica



UNICA
SERIE

P.114



P.123



P.124



P.126-129



P.117



P.115



P.115



P.42





Maatschetsen

Dessins techniques | Dimension drawings | Disegni dimensionali

Topsham Small

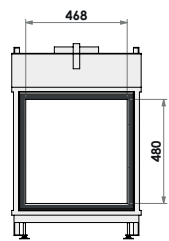

Topsham Large

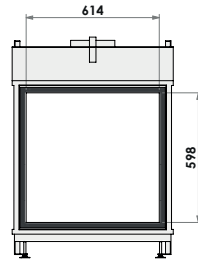

Derby Small

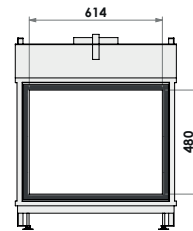

Derby Large

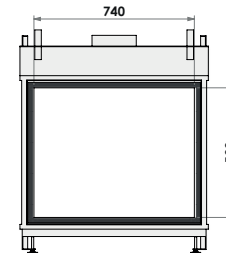

York Small

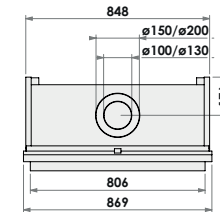
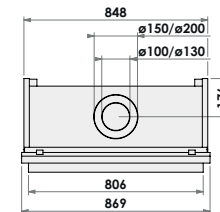
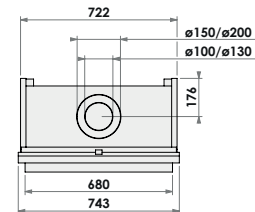
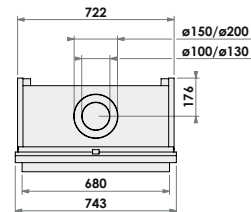
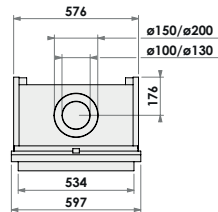
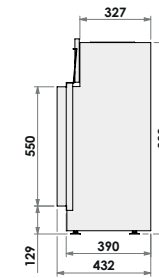
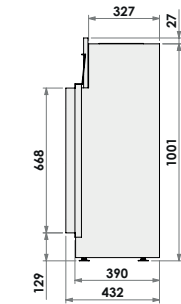
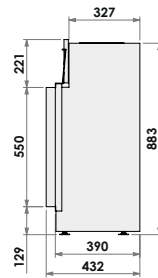
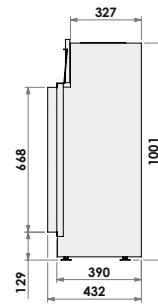
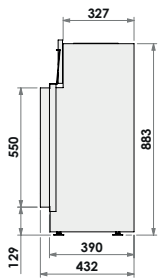
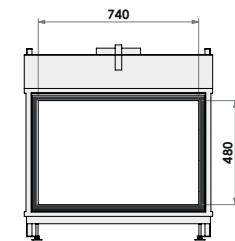

York Large

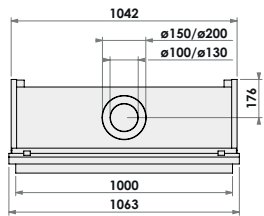
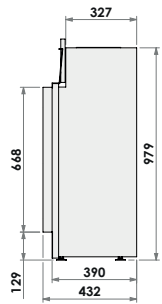
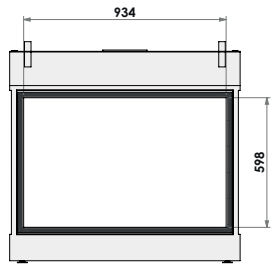

Classic Bell Small

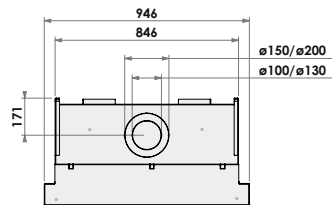
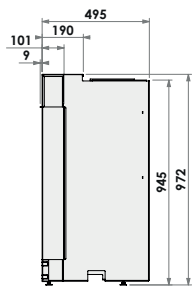
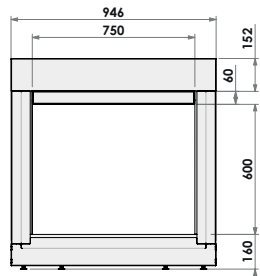

Classic Bell Medium

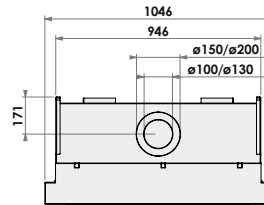
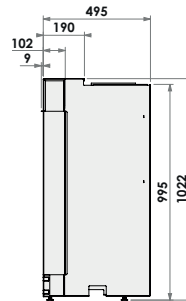
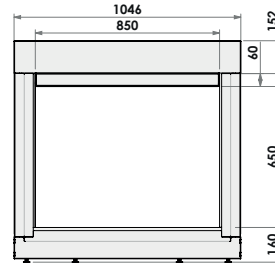

Horizon Bell XS

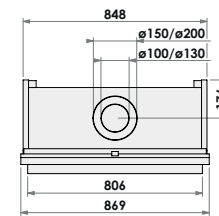
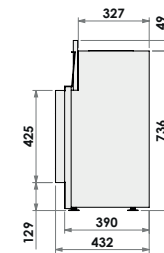

Horizon Bell Small

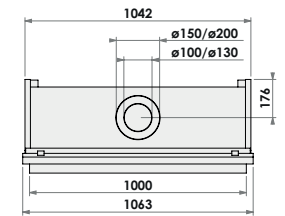
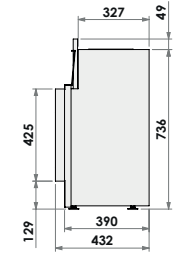
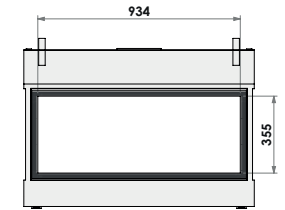



Maatschetsen

Dessins techniques | Dimension drawings | Disegni dimensionali

Horizon Bell Medium

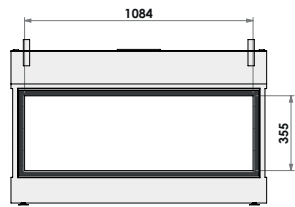

Horizon Bell Large

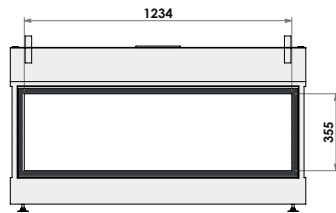

Horizon Bell XL

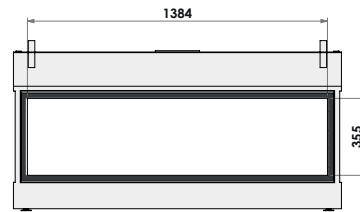

Horizon Bell XXL

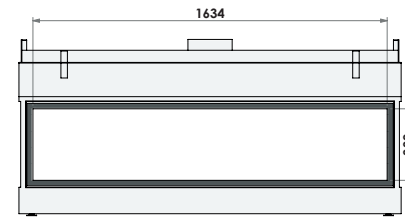

Vertical Bell Small

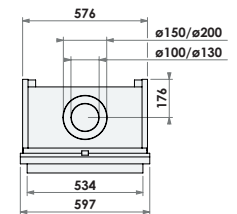
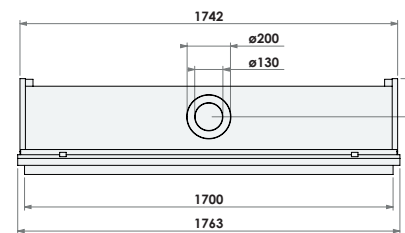
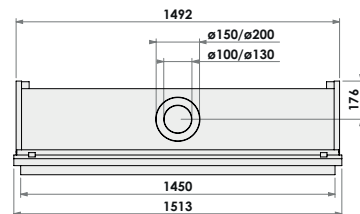
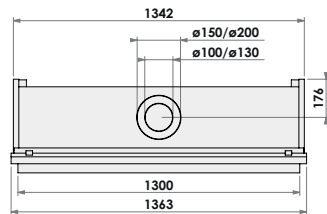
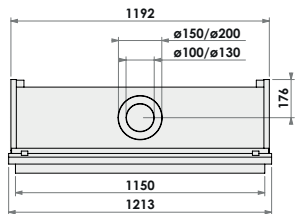
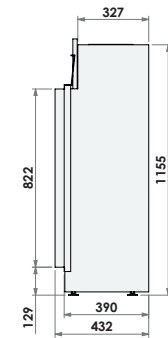
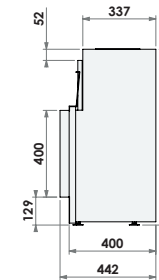
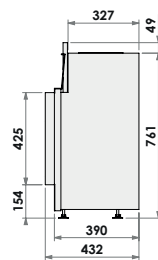
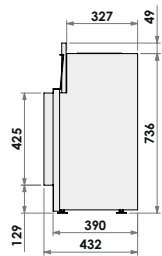
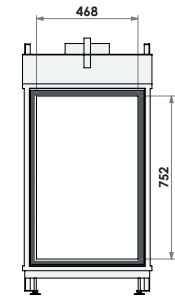



Maatschetsen

Dessins techniques | Dimension drawings | Disegni dimensionali

Smart Bell 65/60

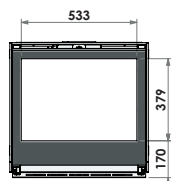

Smart Bell 75/55

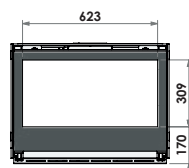

Smart Bell 75/60

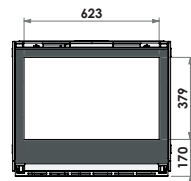

Smart Bell 75/70

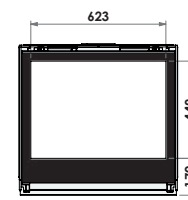

Smart Bell 75/80

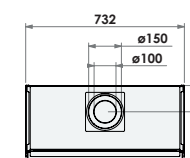
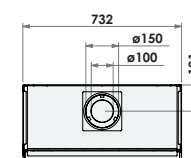
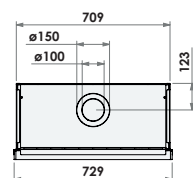
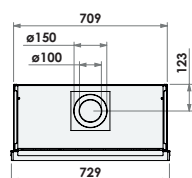
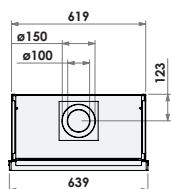
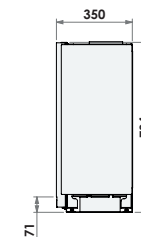
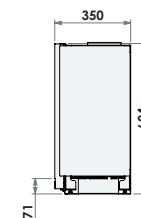
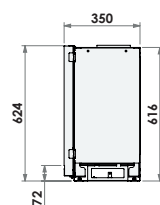
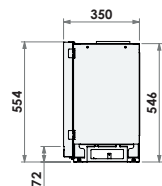
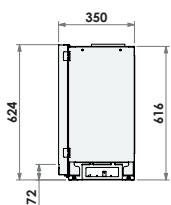
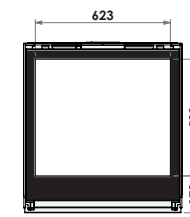

Smart Bell 80/60

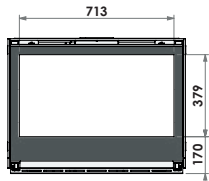

Smart Bell 80/70

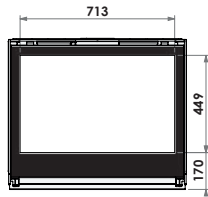

Smart Bell 80/80

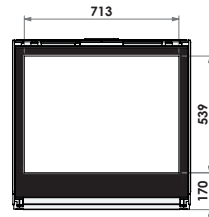

Smart Bell 90/70

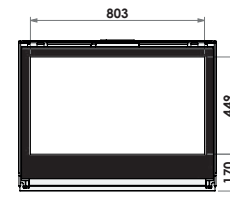

Smart Bell 90/80

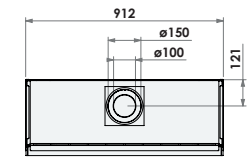
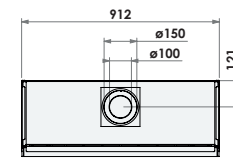
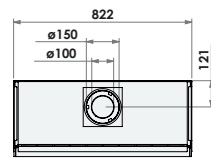
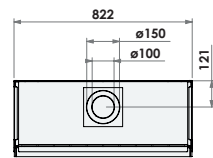
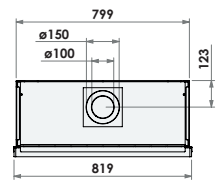
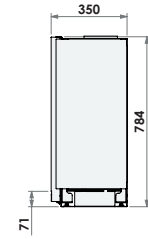
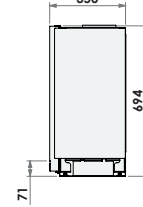
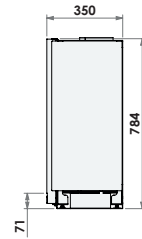
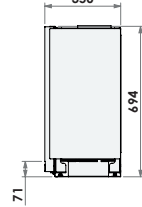
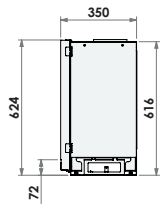
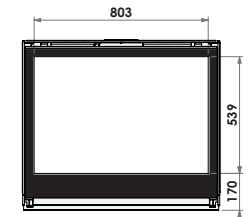



Maatschetsen

Dessins techniques | Dimension drawings | Disegni dimensionali

Unica 40

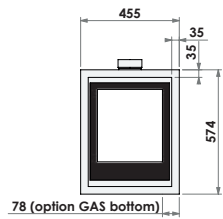

Unica 50

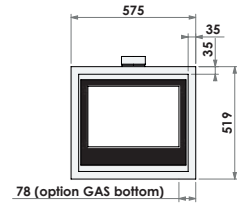

Unica 55

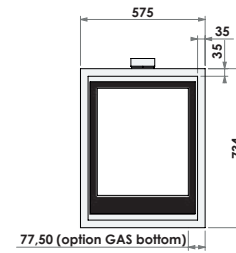

Unica 70

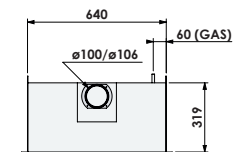
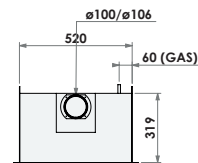
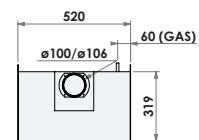
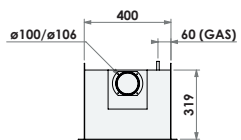
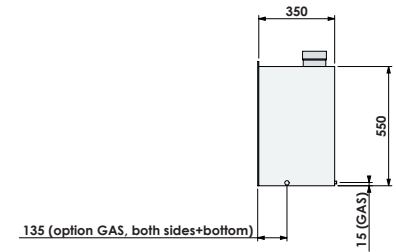
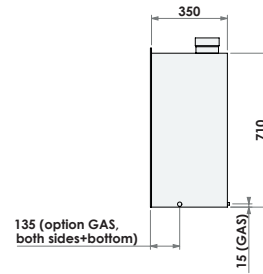
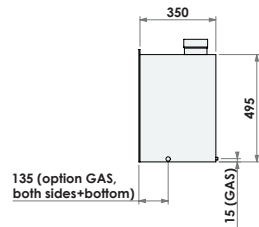
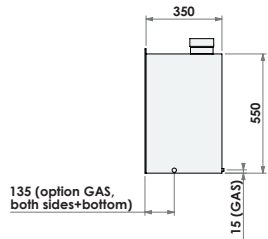
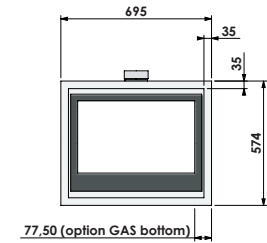

Unica 75

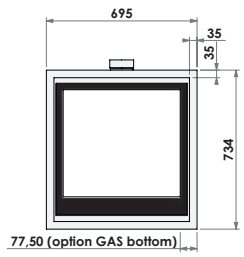

Unica 90

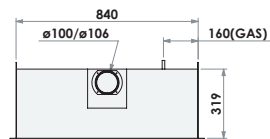
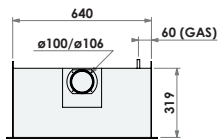
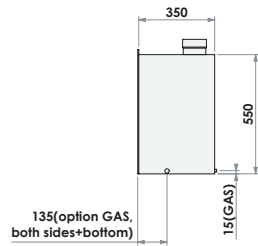
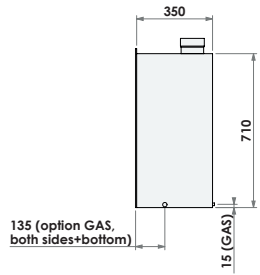
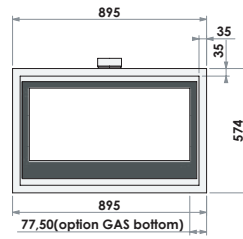

Zichtmaten

Cotes apparentes | Visual dimensions | Dimensioni a vista

	Smart Bell 45/60	Smart Bell 55/55	Smart Bell 55/60	Smart Bell 65/55	Smart Bell 65/60	Smart Bell 75/55	Smart Bell 75/60	Smart Bell 75/80
inbouw kader cadres encastrable built-in frame cornice built-in								
klassiek kader 35 mm cadres classique 35 mm classic frame 35 mm cornice classic 35 mm								
klassiek kader 52 mm cadres classique 52 mm classic frame 52 mm cornice classic 52 mm								
klassiek kader 70 mm cadres classique 70 mm classic frame 70 mm cornice classic 70 mm								
verdiept kader cadres de profondeur insert frame cornice insert								

Smart Bell 75/70 Smart Bell 80/60 Smart Bell 80/70 Smart Bell 80/80 Smart Bell 90/70 Smart Bell 90/80

inbouw kader
cadres encastrable
built-in frame
cornice built-in

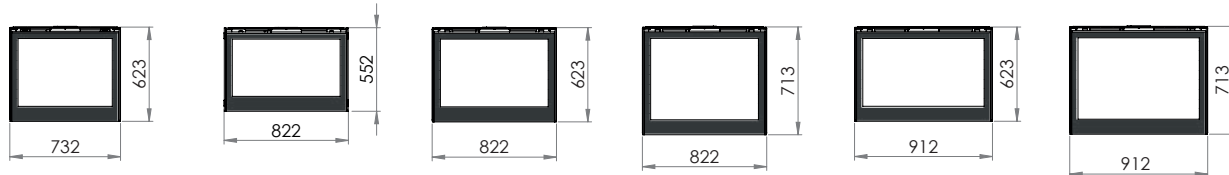

klassiek kader 35 mm
cadres classique 35 mm
classic frame 35 mm
cornice classic 35 mm

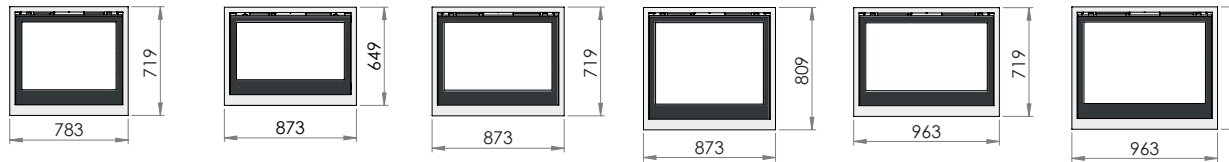

klassiek kader 52 mm
cadres classique 52 mm
classic frame 52 mm
cornice classic 52 mm

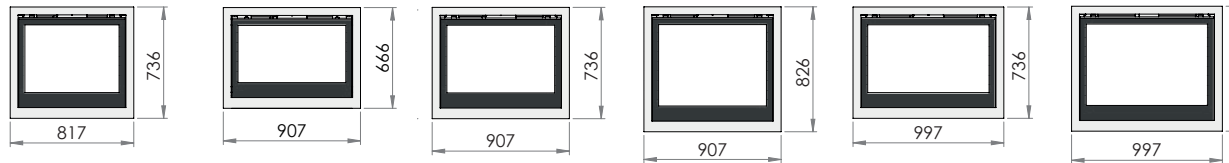

klassiek kader 70 mm
cadres classique 70 mm
classic frame 70 mm
cornice classic 70 mm

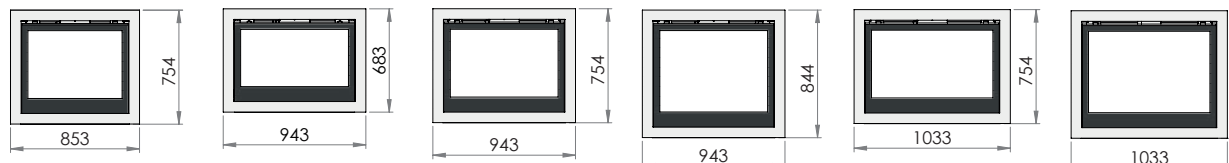

verdiept kader
cadres de profondeur
insert frame
cornice insert

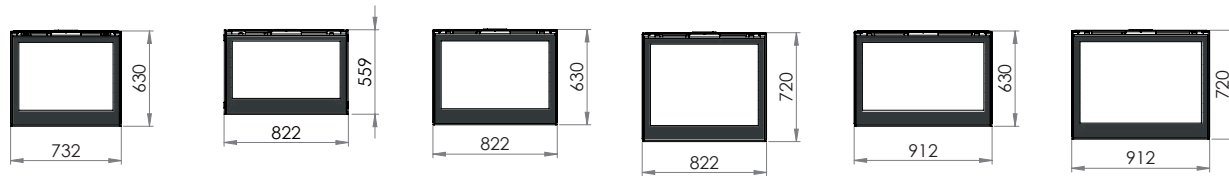

Zichtmaten

Cotes apparentes | Visual dimensions | Dimensioni a vista

Unica 40

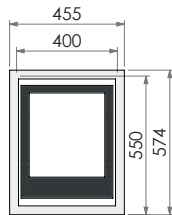

kader 35 mm
cadres 35 mm
frame 35 mm
cornice 35 mm

Unica 50

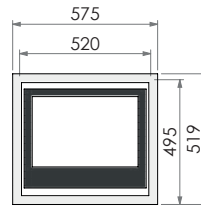

Unica 55

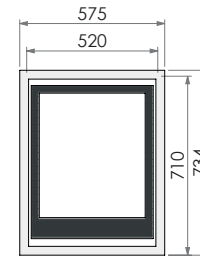

Unica 70

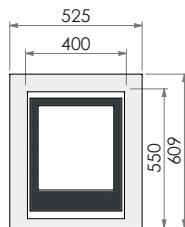
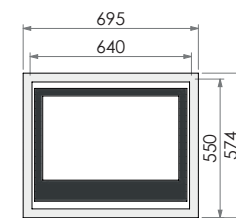

kader 70 mm
cadres 70 mm
frame 70 mm
cornice 70 mm

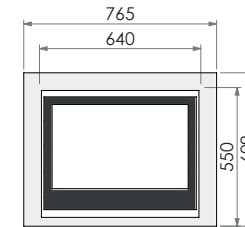
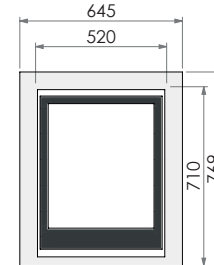
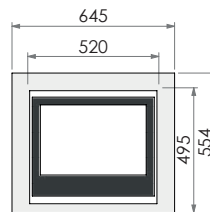

Tweezijdige haarden

Appareils à deux faces | Two-sided fireplaces | Camini bifacciali

- De tweezijdige gashaarden van Bellfires beleef je van twee kanten: zowel links als rechts om de hoek. Een vuurbeleving die zijn investering dubbel en dwars waard is.
- Les appareils au gaz à deux faces de Bellfires offrent une expérience sur deux côtés : tant à gauche qu'à droite de l'angle. Une expérience du feu dont l'investissement en vaut vraiment la peine.
- You can enjoy the Bellfires two-sided gas fireplaces from two sides: from left and right corners. This is an experience of the fire that makes your investment truly worthwhile.
- I camini bifacciali Bellfires possono essere ammirati da due lati: sia a sinistra che a destra. Un'esperienza intensa e coinvolgente che vale l'investimento.



Corner Bell Small	56
Corner Bell Medium	57
Corner Bell Large	58
Corner Bell XL	59
Corner Bell XXL	60
Corner Bell Topsham	61
Corner Bell Derby	62
Corner Bell York	63

Overzicht uitvoeringen

Vue d'ensemble des versions | Overview of versions | Panoramica delle versioni

Original Bell serie

Corner Bell | Links

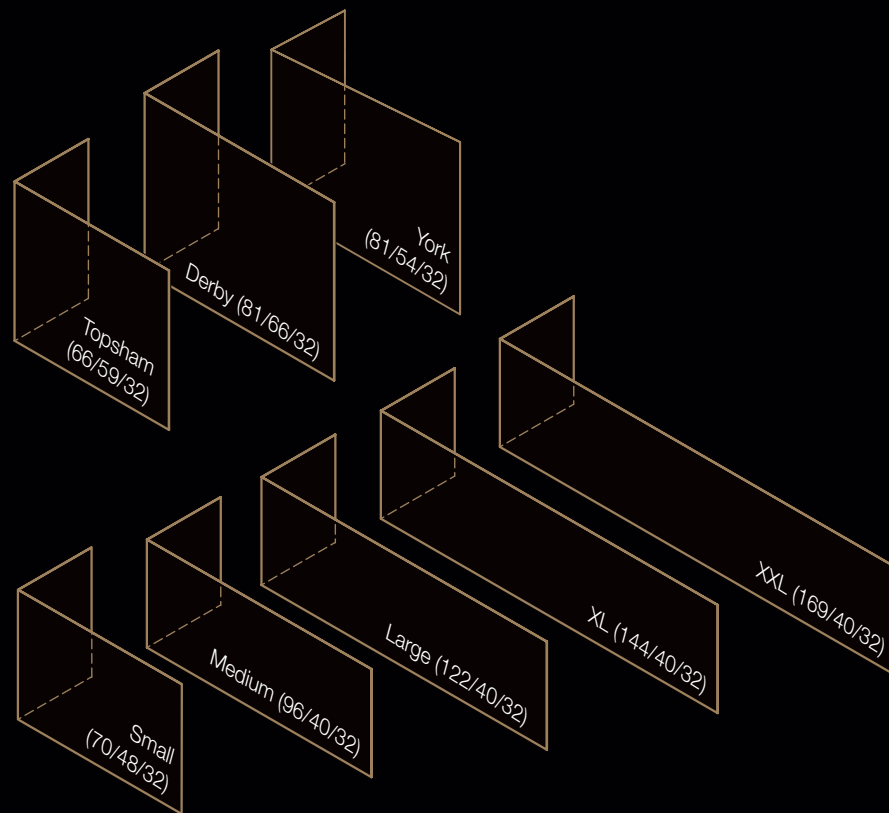

Corner Bell | Rechts

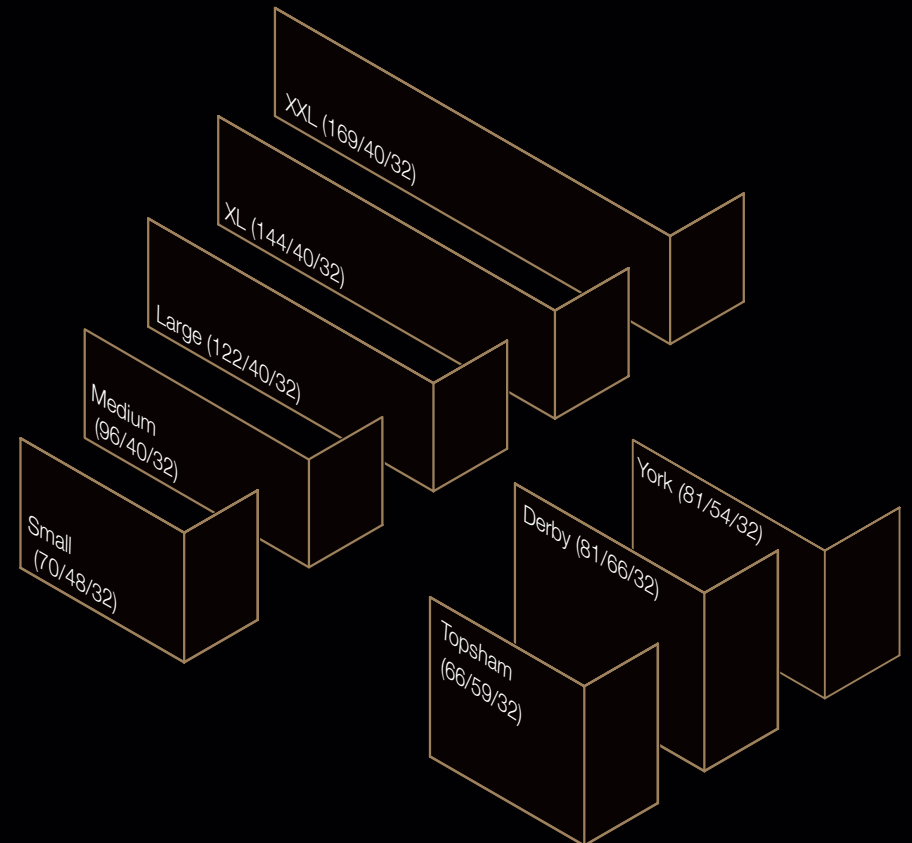

Corner Bell



Small



Medium



Large



XL



XXL



Topsham



Derby



York



B

Kader: Hidden Door | Brander: Line Fire

ORIGINAL BELL
SERIE

P.108



P.118-121



P.123



P.124



P.126-129



P.117



P.117



P.116



P.58

B



Corner Bell



A

Kader: Hidden Door | Brander: Line Fire

ORIGINAL BELL
SERIE

P.108



P.118-119



P.123



P.124



P.126-129



P.117



P.117



P.116



P.58

A



Corner Bell



Kader: Hidden Door +10 cm | Brander: Line Fire

ORIGINAL BELL
SERIE

P.108



P.118-119



P.123



P.124



P.126-129



P.117



P.117



P.116



P.59-60





Corner Bell



A

Kader: Hidden Door | Brander: Premium Flre

ORIGINAL BELL
SERIE

P.108



P.118-121



P.123



P.124



P.126-129



P.117



P.117



P.116



P.60-61



Maatschetsen

Dessins techniques | Dimension drawings | Disegni dimensionali

Corner Bell Small L

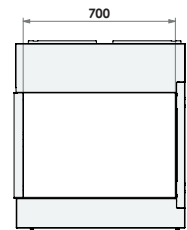

Corner Bell Small R

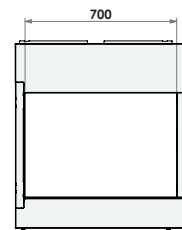

Corner Bell Medium L

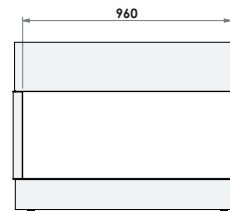

Corner Bell Medium R

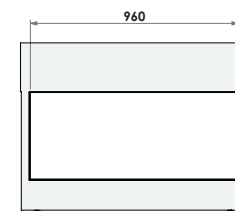

Corner Bell Large L

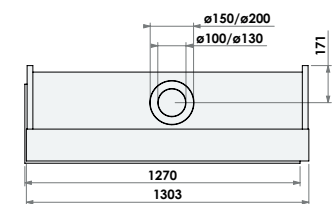
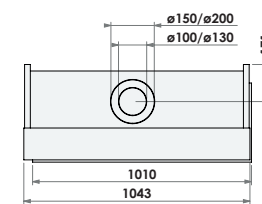
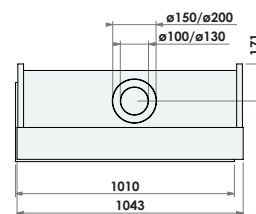
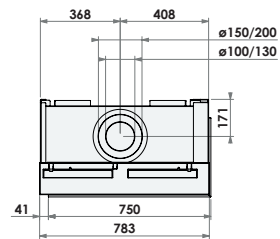
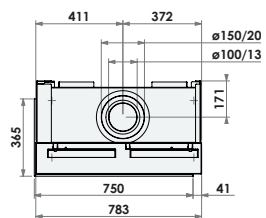
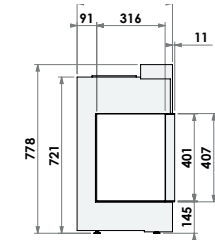
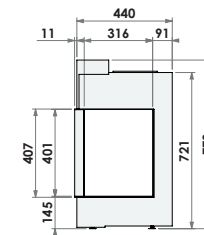
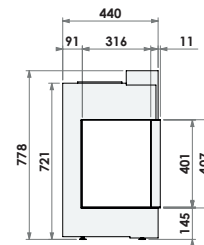
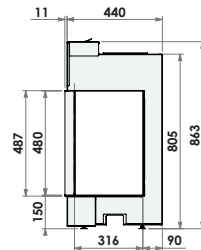
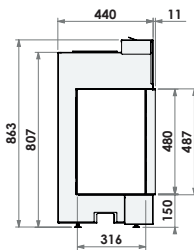
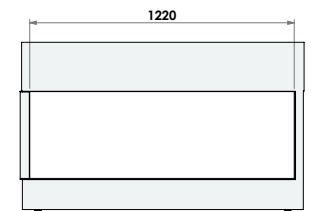

Corner Bell Large R

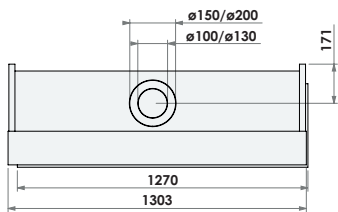
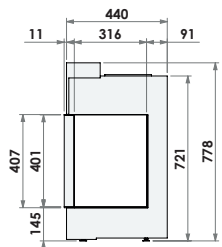
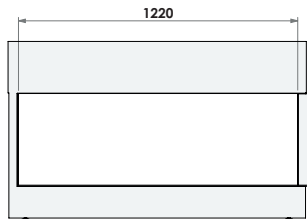

Corner Bell XL L

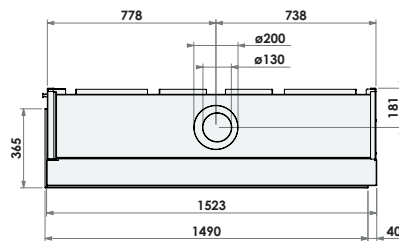
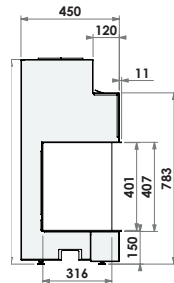
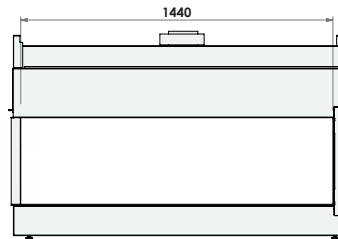

Corner Bell XL R

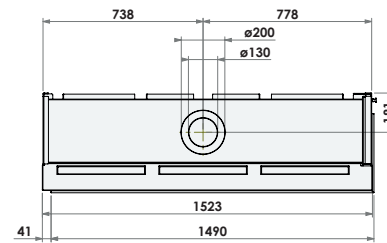
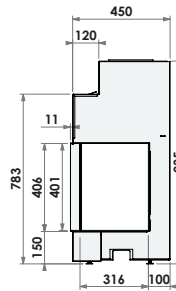
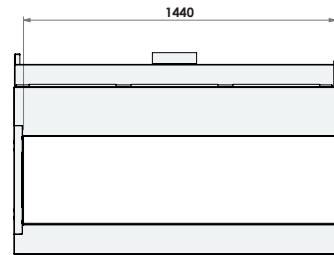

Corner Bell XXL L

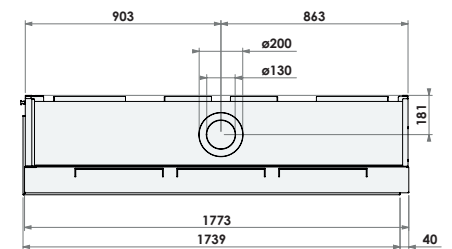
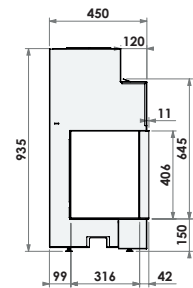



Maatschetsen

Dessins techniques | Dimension drawings | Disegni dimensionali

Corner Bell XXL R

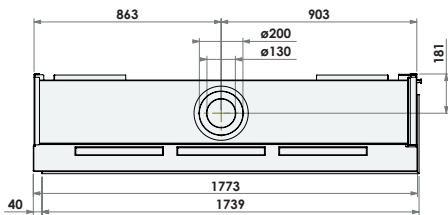
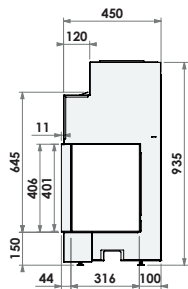
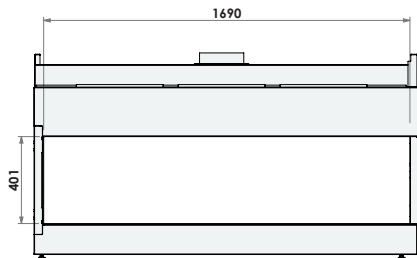

Corner Bell Topsham L

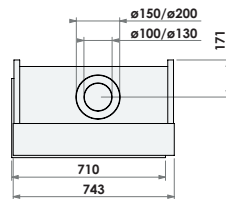
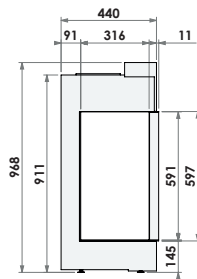
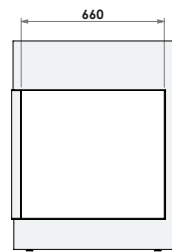

Corner Bell Topsham R

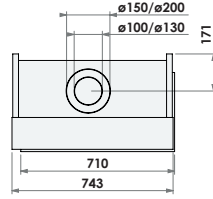
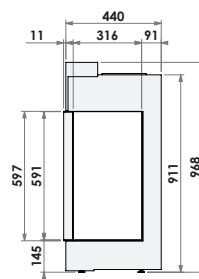
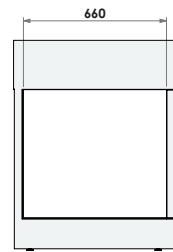

Corner Bell Derby L

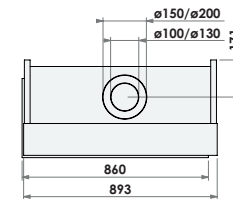
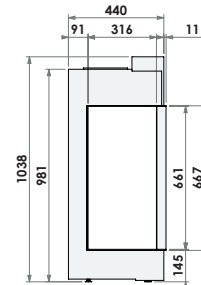
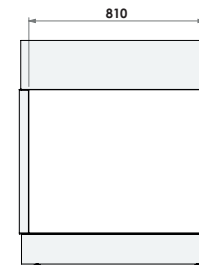

Corner Bell Derby R

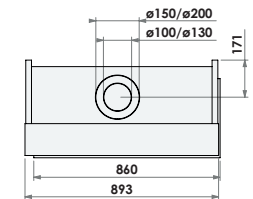
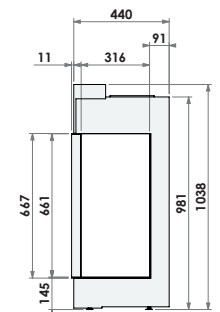
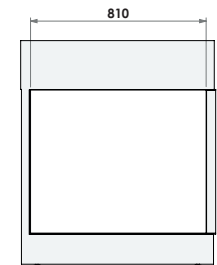

Corner Bell York L

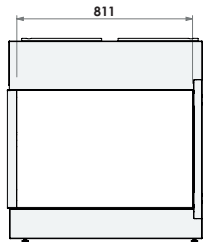

Corner Bell York R

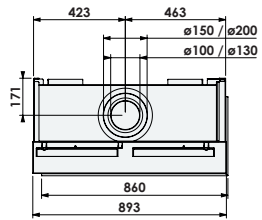
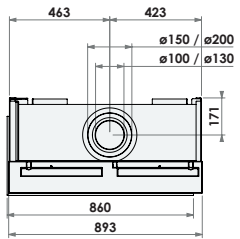
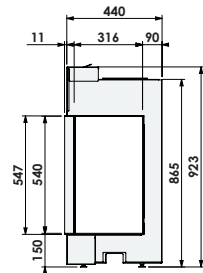
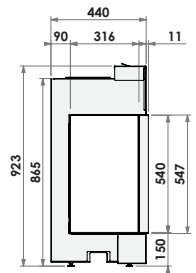
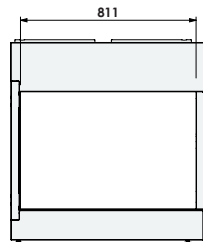





Tunnel haarden

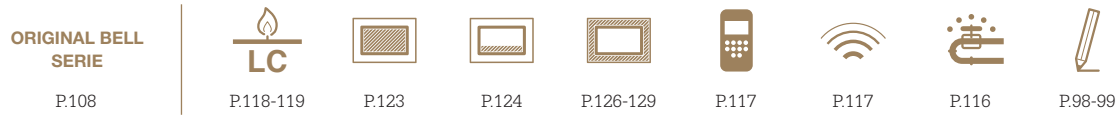
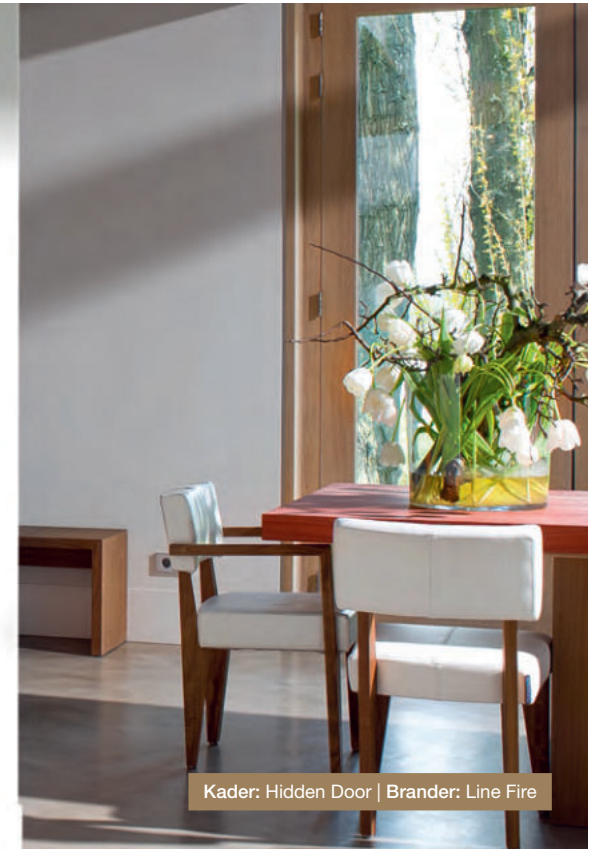

Tunnel haarden



Horizon Bell
Small Tunnel

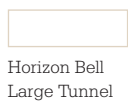

Horizon Bell
Large Tunnel



Vertical Bell
Small Tunnel



Vertical Bell
Medium Tunnel



Derby Large
Tunnel

ORIGINAL BELL
SERIE

P.108



P.118-119



P.123



P.124



P.126-129



P.117



P.117



P.116



P.99







Maatschetsen

Dessins techniques | Dimension drawings | Disegni dimensionali

Horizon Bell Small Tunnel

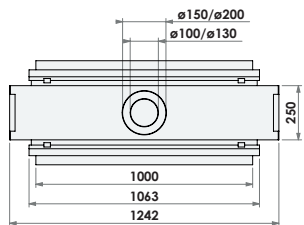
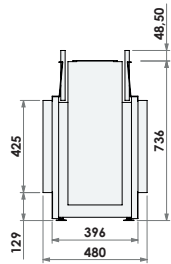
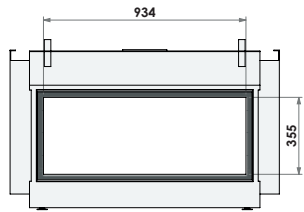

Horizon Bell Large Tunnel

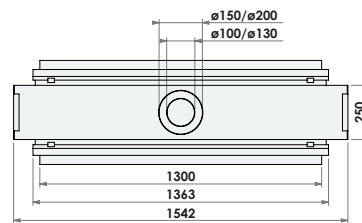
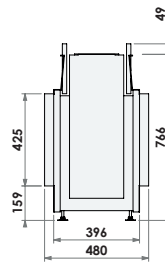

Vertical Bell Small Tunnel

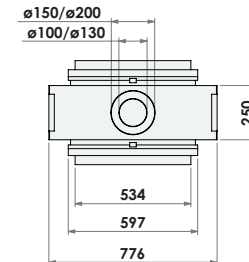
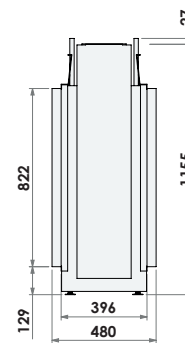
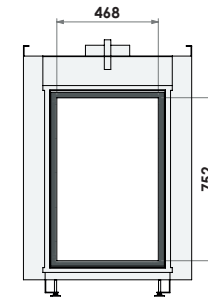

Vertical Bell Medium Tunnel

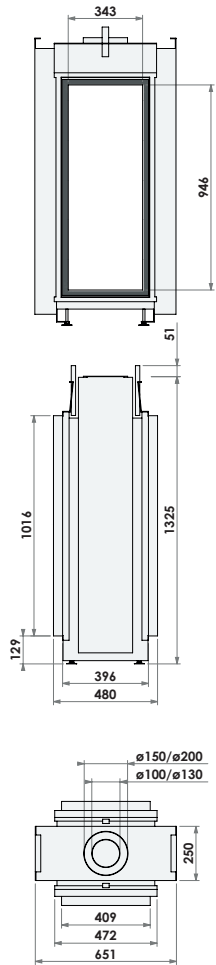

Derby Large Tunnel

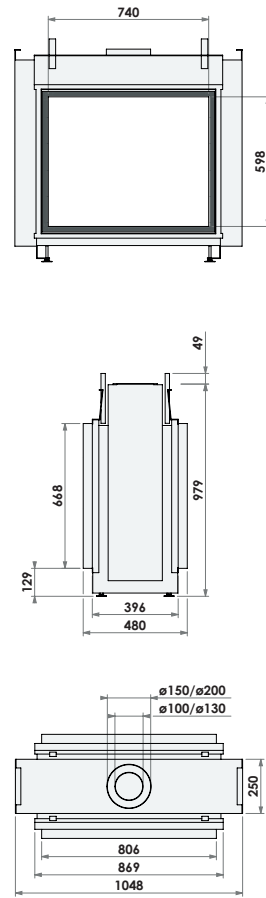

Product overzicht

Vue d'ensemble des produits |
Product overview |
Panoramica dei prodotti

Product	Frame	Energy efficiency class	Interior	Weight (kg)	Burner decoration	Output (kW)	Gas rate
Fronthaarden	Derby Small		A	80		2-7	1,08
Derby Large			A	98		2-8	1,21
Topsham Small			B	70		2-7	0,98
Topsham Large			A	89		2-8	1,18
York Small			A	89		2-8	1,18
York Large			A	126		2-10	1,40
Classic Bell Small			A	122		4-9	1,18
Classic Bell Medium			A	134		4-9	1,18
Horizon Bell XS				80		2-6	0,95
Horizon Bell Small			A	98		2-7	1,10
Horizon Bell Medium			A	112		2-8	1,21
Horizon Bell Large			A	124		2-9	1,30
Horizon Bell XL			A	132		2-10	1,41
Horizon Bell XXL			B	156		2-12	1,60
Vertical Bell Small			B	95		2-7	1,05
Vertical Bell Medium			A	96		2-7	1,05
Smart Bell 45/60	•			50		2-4	0,52
Smart Bell 55/55	•			49		2-4	0,51
Smart Bell 55/60	•			54		2-5	0,62
Smart Bell 65/55	•			56		2-5	0,57
Smart Bell 65/60	•			61		3-5	0,66
Smart Bell 75/55	•			63		2-5	0,64
Smart Bell 75/60	•			67		3-6	0,71
Cadres	Sans cadre						
Cadre encastable							
Cadre classique 35 mm	•						
Cadre classique 52 mm	•						
Cadre classique 70 mm	•						
Cadre de profondeur 15 mm	•						
Cadre de profondeur 50 mm	•						
Hidden Door							
Hidden Door +7 cm	•						
Hidden Door +10 cm	•						
Hidden Door +10 cm & stone bar	•						
Floating Frame							
Cadre 4 faces 35 mm							
Cadre 4 faces 70 mm							
Double brûleurs	Premium fire / energy efficiency class	Premium fire / energy efficiency class	Premium fire / energy efficiency class	Premium fire / energy efficiency class	Premium fire / energy efficiency class	Premium fire / energy efficiency class	Premium fire / energy efficiency class
Line fire / energy efficiency class	Line fire / energy efficiency class	Line fire / energy efficiency class	Line fire / energy efficiency class	Line fire / energy efficiency class	Line fire / energy efficiency class	Line fire / energy efficiency class	Line fire / energy efficiency class
Centre fire / energy efficiency class	Centre fire / energy efficiency class	Centre fire / energy efficiency class	Centre fire / energy efficiency class	Centre fire / energy efficiency class	Centre fire / energy efficiency class	Centre fire / energy efficiency class	Centre fire / energy efficiency class
MagniFire / energy efficiency class	MagniFire / energy efficiency class	MagniFire / energy efficiency class	MagniFire / energy efficiency class	MagniFire / energy efficiency class	MagniFire / energy efficiency class	MagniFire / energy efficiency class	MagniFire / energy efficiency class
Simple brûleurs	Simple burner / energy efficiency class	Simple burner / energy efficiency class	Simple burner / energy efficiency class	Simple burner / energy efficiency class	Simple burner / energy efficiency class	Simple burner / energy efficiency class	Simple burner / energy efficiency class
Intérieurs	steel panels	steel panels	steel panels	steel panels	steel panels	steel panels	steel panels
plain background	plain background	plain background	plain background	plain background	plain background	plain background	plain background
ceramic black mirror interior	ceramic black mirror interior	ceramic black mirror interior	ceramic black mirror interior	ceramic black mirror interior	ceramic black mirror interior	ceramic black mirror interior	ceramic black mirror interior
rustic brick interior red	rustic brick interior red	rustic brick interior red	rustic brick interior red	rustic brick interior red	rustic brick interior red	rustic brick interior red	rustic brick interior red
rustic brick interior grey	rustic brick interior grey	rustic brick interior grey	rustic brick interior grey	rustic brick interior grey	rustic brick interior grey	rustic brick interior grey	rustic brick interior grey
rustic brick interior yellow	rustic brick interior yellow	rustic brick interior yellow	rustic brick interior yellow	rustic brick interior yellow	rustic brick interior yellow	rustic brick interior yellow	rustic brick interior yellow
Industrial interior	Industrial interior	Industrial interior	Industrial interior	Industrial interior	Industrial interior	Industrial interior	Industrial interior
Éclairage d'ambiance	Mood lighting (electrical illumination)	Mood lighting (electrical illumination)	Mood lighting (electrical illumination)	Mood lighting (electrical illumination)	Mood lighting (electrical illumination)	Mood lighting (electrical illumination)	Mood lighting (electrical illumination)
standard	standard	standard	standard	standard	standard	standard	standard
option	option	option	option	option	option	option	option
Poids	kg approx.	kg approx.	kg approx.	kg approx.	kg approx.	kg approx.	kg approx.
Décorations de brûleur	wood logs	wood logs	wood logs	wood logs	wood logs	wood logs	wood logs
grey stones	grey stones	grey stones	grey stones	grey stones	grey stones	grey stones	grey stones
white marble shingles	white marble shingles	white marble shingles	white marble shingles	white marble shingles	white marble shingles	white marble shingles	white marble shingles
Bellfires WiFi module	Bellfires WiFi module	Bellfires WiFi module	Bellfires WiFi module	Bellfires WiFi module	Bellfires WiFi module	Bellfires WiFi module	Bellfires WiFi module
option	option	option	option	option	option	option	option
Puissance (kW)	natural gas (min-max)	natural gas (min-max)	natural gas (min-max)	natural gas (min-max)	natural gas (min-max)	natural gas (min-max)	natural gas (min-max)
Gaz Naturel (min-max)	natural gas (m ³ /hr). Only UK.	natural gas (m ³ /hr). Only UK.	natural gas (m ³ /hr). Only UK.	natural gas (m ³ /hr). Only UK.	natural gas (m ³ /hr). Only UK.	natural gas (m ³ /hr). Only UK.	natural gas (m ³ /hr). Only UK.
Consommation	natural gas (m ³ /hr)	natural gas (m ³ /hr)	natural gas (m ³ /hr)	natural gas (m ³ /hr)	natural gas (m ³ /hr)	natural gas (m ³ /hr)	natural gas (m ³ /hr)
Gaz naturel (m ³ /hr)	propane (gr/hr)	propane (gr/hr)	propane (gr/hr)	propane (gr/hr)	propane (gr/hr)	propane (gr/hr)	propane (gr/hr)
Seulement UK.							
Gaz naturel (m ³ /hr)							
Propane (gr/hr)							

Combustion system	Gas flue outlet / air supply	Ø (mm)	Type of gas ³	Convection casing	Convection fan system	Flue outlet
conventional flue	conventional flue	100-150/130-200	natural gas	standard	option	unlined. Only UK.
balanced flue	balanced flue	100-150/130-200	propane	option	option	lined
		100-150/130-200	butane			concentric
		100-150/130-200				
		100-150/130-200				
		100-150/130-200				
		100-150/130-200				
		100-150/130-200				
		100-150/130-200				
		100-150/130-200				
		100-150/130-200				
		100-150/130-200				
		100-150/130-200				
		100-150/130-200				
		100-150/130-200				
		100-150/130-200				
		100-150/130-200				
		100-150/130-200				
		130-200				
		100-150/130-200				
		100-150/130-200				
		100-150				
		100-150				
		100-150				
		100-150				
		100-150				
		100-150				
		100-150				
		100-150				

¹ Not possible with propane/ butane.

² Mood lighting comes standard when the appliance is equipped with a Premium Fire double burner or with a MagniFire double burner.

³ Type of gas and burner decoration influence flame appearance (height).

The technical values in this table are indicative, and may differ per country and gas pressure.
For an exact representation please refer to the installation manual.

¹ Pas possible au propane/butane.

² L'éclairage d'ambiance est standard lorsque l'appareil est équipé d'un double brûleur Premium Fire ou MagniFire.

³ Le type de gaz et la décoration de brûleur influencent l'esthétique et la hauteur de la flamme.

Les valeurs techniques dans ce tableau sont indicatives et peuvent différer selon les pays et les pressions de gaz.
Pour connaître sa valeur exacte, vous pouvez consulter le manuel d'installation.

Product overzicht

Vue d'ensemble des produits |
Product overview |
Panoramica dei prodotti

Fronthaarden (vervolg)

Smart Bell 75/70
Smart Bell 75/80
Smart Bell 80/60
Smart Bell 80/70
Smart Bell 80/80
Smart Bell 90/70
Smart Bell 90/80
Unica 40
Unica 50
Unica 55
Unica 70
Unica 75
Unica 90

	•	•	•	•	•	•	•													
	•	•	•	•	•	•	•													
	•	•	•	•	•	•	•													
	•	•	•	•	•	•	•													
	•	•	•	•	•	•	•													

Tweezijdige haarden

Corner Bell Small
Corner Bell Medium
Corner Bell Large
Corner Bell XL
Corner Bell XXL
Corner Bell Derby
Corner Bell Topsham
Corner Bell York

Cadres

Sans cadre
Cadre encastrable
Cadre classique 35 mm
Cadre classique 52 mm
Cadre classique 70 mm
Cadre de profondeur 15 mm
Cadre de profondeur 50 mm
Hidden Door
Hidden Door +7 cm
Hidden Door +10 cm
Hidden Door +10 cm & stone bar
Floating Frame
Cadre 4 faces 35 mm
Cadre 4 faces 70 mm

Double brûleurs

Premium Fire /
Classe d'efficacité énergétique
Line Fire /
Classe d'efficacité énergétique
Centre Fire /
Classe d'efficacité énergétique
MagniFire /
Classe d'efficacité énergétique

Simple brûleurs

Simple brûleur / Classe d'efficacité énergétique

Intérieurs

Lamelles en acier
Fond lisse
Miroir céramique noir
Inérieur rustique en briques rouges
Inérieur rustique en briques grises
Inérieur rustique en briques jaunes
Industrial interior

Éclairage d'ambiance

Standard
Option

Poids

kg

Décorations de brûleur

Bûches céramique
Cailloux gris
Cailloux blancs

Bellfires Module Wi-Fi

Option

Puissance (kW)

Gaz Naturel (min-max)
Gaz Naturel (min-max)

Consommation

Gaz naturel (m³/hr)
Seulement UK.
Gaz naturel (m³/hr)

Propane (gr/hr)

Frame

frameless
built-in frame
classic frame 35 mm
classic frame 52 mm
classic frame 70 mm
insert frame 15 mm
insert frame 50 mm
Hidden Door
Hidden Door +7 cm
Hidden Door +10 cm
Hidden Door +10 cm & stone bar
Floating Frame
4-sided frame 35 mm.
4 sided frame 70 mm.

Double burner

Premium fire / energy efficiency class
Line fire / energy efficiency class
Centre fire / energy efficiency class
MagniFire / energy efficiency class

Single burner

Single burner / energy efficiency class

Interior

steel panels
plain background
ceramic black mirror interior
rustic brick interior red
rustic brick interior grey
rustic brick interior yellow
Industrial interior

Mood lighting (electrical illumination)

standard
option

Weight

kg. approx.

Burner decoration

wood logs
grey stones
white marble shingles

Bellfires WiFi module

option

Output (kW)

natural gas (min-max). Only UK.
natural gas (min-max)

Gas rate

natural gas (m³/hr). Only UK.
natural gas (m³/hr)
propane (gr/hr)

Model	Frame	Double burner	Single burner	Interior	Mood lighting	Weight	Burner decoration	Bellfires WiFi module	Output (kW)	Gas rate
Smart Bell 75/70	•	B ¹			•	80				
Smart Bell 75/80	•	B ¹			•	87			3-7	1,05
Smart Bell 80/60	•		B		•	74			3-8	1,13
Smart Bell 80/70	•	B ¹			•	87			3-7	0,80 450
Smart Bell 80/80	•	B ¹			•	95			3-7	1,05
Smart Bell 90/70	•	B ¹			•	93			3-8	1,13
Smart Bell 90/80	•	B ¹			•	100			3-7	1,05
Unica 40				C	•	41	•		2-4 2-4	0,59 0,61 360
Unica 50				D	•	45	•		2-5 2-5	0,68 0,72 450
Unica 55				D	•	58	•		2-5 2-5	0,68 0,72 450
Unica 70				D	•	54	•		2-6 2-7	0,65 0,86 480
Unica 75				D	•	64	•		2-6 2-7	0,65 0,86 480
Unica 90				D	•	58	•		2-8 2-9	0,68 0,72 450
Corner Bell Small		A B B			• ²	82	•		2-7	1,10 670
Corner Bell Medium		B B			•	96	•		2-8	1,21 750
Corner Bell Large		A B			•	115	•		2-9	1,30 750
Corner Bell XL		A A			•	132	•		2-10	1,41 860
Corner Bell XXL		A A			•	180	•		2-10	1,41 860
Corner Bell Derby		A B A			• ²	98	•		2-8	1,17 700
Corner Bell Topsham		A A A			• ²	90	•		2-8	1,17 700
Corner Bell York		A B A			• ²	98	•		2-8	1,17 700

Système de combustion	Combustion system				
Conduit conventionnel	conventional flue				
Ventouse	balanced flue				
Sortie de conduit de gaz	Gas flue outlet / air supply				
Ø (mm)	Ø (mm)				
Type de gaz ³	Type of gas ³				
Gaz Naturel	natural gas				
Propane	propane				
Butane	butane				
Caisse de convection	Convection casing				
Standard	standard				
Option	option				
Ventilateur de convection	Convection fan system				
Option	option				
Raccordement du conduit	Flue outlet				
Par l'arrière. Seulement UK.	unlined. Only UK.				
Au dessus	lined				
Concentrique	concentric				

¹ Not possible with propane/ butane.

² Mood lighting comes standard when the appliance is equipped with a Premium Fire double burner or with a MagniFire double burner.

³ Type of gas and burner decoration influence flame appearance (height).

The technical values in this table are indicative, and may differ per country and gas pressure.

For an exact representation please refer to the installation manual.

¹ Pas possible au propane/butane.

² L'éclairage d'ambiance est standard lorsque l'appareil est équipé d'un double brûleur Premium Fire ou MagniFire.

³ Le type de gaz et la décoration de brûleur influencent l'esthétique et la hauteur de la flamme.

Les valeurs techniques dans ce tableau sont indicatives et peuvent différer selon les pays et les pressions de gaz.

Pour connaître sa valeur exacte, vous pouvez consulter le manuel d'installation.

Système de combustion	Combustion system						
Conduit conventionnel	conventional flue						
Ventouse	balanced flue						
Sortie de conduit de gaz	Gas flue outlet / air supply						
Ø (mm)	Ø (mm)						
Type de gaz ³	Type of gas ³						
Gaz Naturel	natural gas						
Propane	propane						
Butane	butane						
Caisse de convection	Convection casing						
Standard	standard						
Option	option						
Ventilateur de convection	Convection fan system						
Option	option						
Raccordement du conduit	Flue outlet						
Par l'arrière. Seulement UK.	unlined. Only UK.						
Au dessus	lined						
Concentrique	concentric						

¹ Not possible with propane/ butane.

² Mood lighting comes standard when the appliance is equipped with a Premium Fire double burner or with a MagniFire double burner.

³ Type of gas and burner decoration influence flame appearance (height).

The technical values in this table are indicative, and may differ per country and gas pressure.

For an exact representation please refer to the installation manual.

¹ Pas possible au propane/butane.

² L'éclairage d'ambiance est standard lorsque l'appareil est équipé d'un double brûleur Premium Fire ou MagniFire.

³ Le type de gaz et la décoration de brûleur influencent l'esthétique et la hauteur de la flamme.

Les valeurs techniques dans ce tableau sont indicatives et peuvent différer selon les pays et les pressions de gaz.

Pour connaître sa valeur exacte, vous pouvez consulter le manuel d'installation.

Warmtebepaling

La chaleur requise | Heat requirements | Fabbisogno Energetico

- Hoe bepaal ik het vermogen dat mijn haard of kachel moet hebben om de gewenste ruimte te verwarmen?

U kunt op eenvoudige wijze het vermogen bepalen van de haard of de kachel dat u nodig heeft om de gewenste ruimte te verwarmen. In de grafiek hieronder ziet u het vermogen uitgedrukt in kilowatt (kW). De te verwarmen ruimte wordt uitgedrukt in kubieke meters (m³). Het aantal kubieke meters bepaalt u door de lengte, breedte en hoogte van de ruimte met elkaar te vermenigvuldigen. Op het snijpunt van één van de drie lijnen kunt u vervolgens het benodigde vermogen aflezen. Welke van de drie lijnen u moet kiezen, hangt af van de mate waarin uw woning is geïsoleerd.

Lijn A:

geldt voor een goed geïsoleerde woning. De woning is voorzien van dubbele beglazing, muurisolatie en vloerisolatie.

Lijn B:

geldt voor een redelijk geïsoleerde woning. De woning is minimaal voorzien van dubbele beglazing.

Lijn C:

geldt voor een slecht geïsoleerde woning. De woning heeft geen van de hierboven genoemde vormen van isolatie.

Let op!

Er zijn echter ook nog bepaalde factoren waardoor het warmteverlies in de woning vergroot wordt. Denkt u maar eens aan een open keuken of een open trap. Hierdoor gaat veel warmte verloren. Dit warmteverlies kan worden opgevangen door in dergelijke situaties een haard of kachel met een groter vermogen te kiezen. Daarom adviseren wij u altijd met uw vakspecialist te overleggen voordat u een keuze maakt.

- Comment déterminer la puissance de mon foyer ou poêle pour chauffer la pièce souhaitée?

Vous pouvez déterminer aisément la puissance requise du foyer ou du poêle pour chauffer une pièce. Dans le graphique ci-dessous, vous voyez la puissance exprimée en kilowatts (kW). La pièce à chauffer est exprimée en mètres cubes (m³). Le nombre de mètres cubes se calcule en multipliant la longueur, la largeur et la hauteur de la pièce. À l'intersection de l'une des trois lignes, vous pouvez ensuite lire la puissance requise. La ligne que vous devez sélectionner dépend du degré d'isolation de votre logement.

La ligne A:

est d'application pour un logement bien isolé. Le logement est doté de double vitrage, d'une isolation murale et d'une isolation du sol.

La ligne B:

est d'application pour un logement raisonnablement isolé. Le logement est doté au minimum de double vitrage.

La ligne C:

est d'application pour un logement mal isolé. Le logement ne bénéficie d'aucune des formes d'isolation susmentionnées.

Attention!

Il existe encore d'autres facteurs qui augmentent la perte de chaleur dans le logement. Songez à une cuisine ouverte ou à un escalier ouvert. De ce fait, une grande quantité de chaleur est perdue. Dans de telles situations, cette perte de chaleur peut être compensée en sélectionnant un foyer ou un poêle d'une puissance supérieure. C'est pourquoi nous vous recommandons de toujours consulter votre spécialiste avant d'opérer un choix.

- How do I determine the capacity my fire or stove needs to heat the area in which it is situated?

You can easily determine the capacity of the fire or the stove you need to heat the chosen area. In the graph below, the capacity is expressed in kilowatt (kW). The area to be heated is expressed in cubic metres (m³). You calculate the number of cubic metres by multiplying length, height and width of the room together. You can then read the required capacity at the intersection on one of the three lines. Which of the three lines you should choose depends on the extent of insulation in your home.

Line A:

applies to a well-insulated house. It is fitted with double glazing, wall insulation and floor insulation.

Line B:

applies to a reasonably insulated house. The house has at least double glazing.

Line C:

applies to a badly insulated house. The house has none of the insulation mentioned above.

Important!

There are, however, certain factors which increase the heat loss in the house. Things like an open kitchen or an open staircase. These can allow a lot of heat to escape. This heat loss can be compensated by choosing a fire or stove with a higher capacity in such situations. That is why we would always advise you to consult your professional dealer before making a choice.

■ Come determinare la corretta Potenza del caminetto o della stufa idonea a riscaldare l'ambiente di installazione?

Potete facilmente determinare la potenza del caminetto o della stufa necessarie per riscaldare l'area prescelta. Nel grafico sotto riportato la potenza è espressa in kilowatt (Kw). L'area da riscaldare è espressa in metri cubi (m³).

Calcolate il volume dell'area moltiplicando lunghezza, altezza e larghezza della stanza.

Il punto di intersezione di questi valori su una delle tre linee indica la potenza richiesta. La scelta tra le 3 rette dipende dal tipo di isolamento della vs. casa.

Retta A:

Si applica ad una casa isolata, dotata di doppio tetto, isolamento alle pareti ed al pavimento.

Retta B:

Si applica ad una casa con isolamento discreto che dispone almeno di un doppio tetto.

Retta C:

Si applica ad una casa con cattivo isolamento che non dispone di alcuna delle caratteristiche sopra menzionate.

Importante!

Vi sono fattori che possono aumentare le perdite di calore in una casa. Elementi quali una cucina o un vano scale aperti possono peggiorare ulteriormente la situazione.

Queste perdite di calore possono essere compensate dall'adozione di un caminetto o di una stufa più potenti.

Per questo motivo consigliamo sempre di consultare un tecnico professionista per scegliere il prodotto più idoneo.

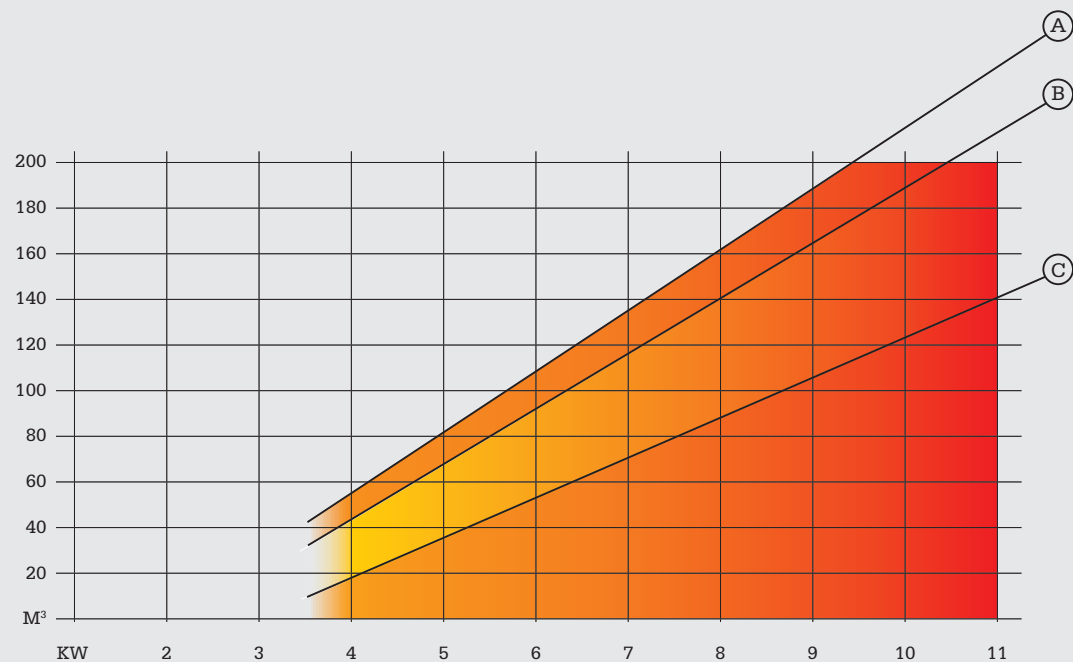

Original Bell serie

Série Original Bell | Original Bell series | Serie Original Bell

- 1 ■ Meer installatiemogelijkheden door rookgasafvoer in zowel 100/150 en 130/200.
■ Plus de possibilités d'installation grâce à l'évacuation des fumées dans les deux diamètres 100/150 et 130/200.
■ Flue connections of 100/150 and 130/200 provide more installation possibilities.
■ Maggiori possibilità di installazione grazie tubo di scarico fumi da 100/150 e 130/200.

- 2 ■ Gesloten systeem, dus een hoger rendement.
■ Système à ventouse, pour un rendement plus élevé.
■ Closed system, therefore a higher yield.
■ Sistema chiuso, rendimento più alto.

- 3 ■ Optimaal zicht op het vuur, met naar keuze gepolijst of ontspiegeld glas.
■ Vue optimale sur le feu, avec vitre polie ou antireflet au choix.
■ Enhanced view of the fire with a choice of polished or non-reflective glass.
■ Visuale sul fuoco ottimale, con scelta tra vetro di serie o antiriflesso.

- 4 ■ Passend in ieder interieur met keuze uit diverse kaders.
■ Se marie avec chaque intérieur avec un choix de différents cadres.
■ Suitable for every interior with a choice of various frames.
■ Adattabile a qualsiasi arredamento grazie alla possibilità di scelta tra diverse cornici.

- 5 ■ Maak je haard persoonlijk, met diverse keuzes in interieur en brander decoratie.
■ Personnalisez votre appareil, avec plusieurs choix d'intérieurs et de décorations de brûleur.
■ Give your fireplace a personal touch with various choices for the interior and burner decoration.
■ Personalizzate il vostro camino con le svariate possibilità di scelta del rivestimento interno e della decorazione dei bruciatori.

- 6 ■ Veilig en gemakkelijk in gebruik, door het gepatenteerde deurmechanisme.
■ Utilisation sûre et facile grâce au mécanisme de porte breveté.
■ Patented door mechanism makes it safe and easy to use.
■ Sicuro e di facile utilizzo grazie allo sportello con meccanismo brevettato.

- 7 ■ Altijd een haard die past, dankzij de vele maatvarianten.
■ Il y a toujours un appareil adapté grâce aux nombreuses dimensions.
■ There is always a suitable fireplace thanks to the many sizes available.
■ Un camino che calza a pennello in ogni ambiente grazie alle diverse misure disponibili.

- 8 ■ Gebruiksgemak ten top, bediening middels handzender of optionele App.
■ Utilisation simplissime par une télécommande ou une application en option.
■ Super easy to use, operates by remote control or an optional App.
■ Comodità d'uso superiore con la gestione tramite telecomando o app opzionale.



Smart Bell serie

Série Smart Bell | Smart Bell series | Serie Smart Bell

- Door de concentrische rookgasafvoer van 100/150 ook perfect geschikt voor renovatie.
 - Grâce au conduit concentrique de 100/150, ces appareils conviennent parfaitement pour la rénovation.
 - The 100/150 flue connection allows installation into existing chimneys with the flex kit.
 - Con il tubo di scarico fumi da 100/150 è perfetto anche per interventi di ristrutturazione.
- Gesloten systeem, dus een hoger rendement.
 - Système à ventouse, pour un rendement plus élevé.
 - Closed system, therefore a higher yield.
 - Sistema chiuso, rendimento più alto.
- Een prachtig vuurbeeld, dankzij de standaard schakelbare MagniFire of Premium Fire.
 - Une magnifique vue sur les flammes grâce au Magnifire ou Premium Fire modulable et standard.
 - An amazing display of fire thanks to the standard switchable MagniFire or Premium Fire.
 - Un fuoco dall'aspetto incantevole grazie al MagniFire commutabile standard o al Premium Fire.
- De sfeerverlichting geeft extra vuurbeleving.
 - L'éclairage d'ambiance optimise l'expérience du feu.
 - The ambient lighting provides added enjoyment of the fire.
 - L'illuminazione d'ambiente per un'esperienza ancora più coinvolgente.
- De minimale diepte van 35 cm, biedt extra inbouwvrijheid.
 - La profondeur minimale de 35 cm offre une liberté d'encastrement supplémentaire.
 - The minimum depth of 35 cm offers additional freedom in building it in.
 - La profondità minima di 35 cm offre maggiore libertà di incasso.
- Eenvoudig in onderhoud, alle techniek is van voren te bereiken.
 - Facile à entretenir, toute la technique étant accessible par l'avant.
 - Easy to maintain, all the technical parts can be reached from the front side.
 - Di facile manutenzione dato che tutti i comandi sono accessibili dalla parte anteriore.
- Extra stookcomfort met de optionele convectieventilator.*
 - Confort supplémentaire avec le ventilateur de convection en option.*
 - Additional burning comfort with the optional convection fan.*
 - Calore molto confortevole grazie al ventilatore di convezione.*
- Passend in ieder interieur met keuze uit diverse kaders.
 - Se marie avec chaque intérieur avec un choix de différents cadres.
 - Suitable for every interior with a choice of various frames.
 - Adattabile a qualsiasi arredamento grazie alla possibilità di scelta tra diverse cornici.

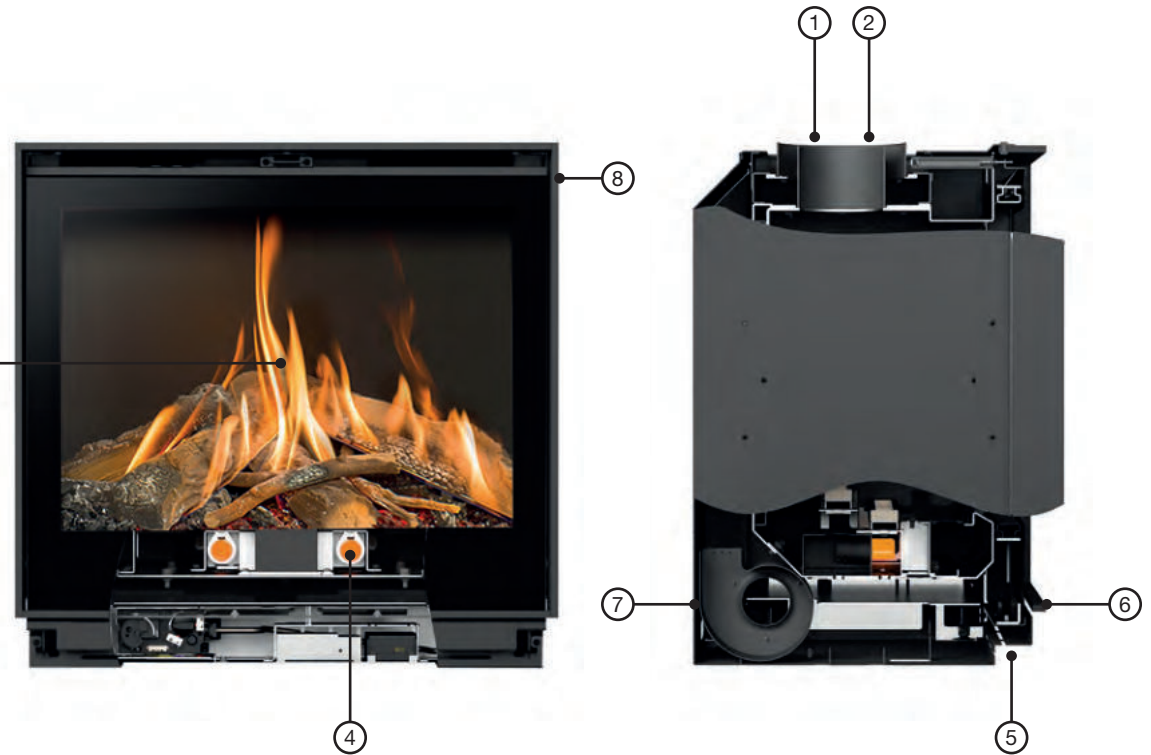

* Let op: 5,5 cm extra inbouwdiepte. | Veuillez noter: profondeur d'installation supplémentaire de 5,5 cm. | Note: 5,5 cm extra installation depth. | Nota: profondità di installazione extra di 5,5 cm.

Unica serie

Série Unica | Unica series | Serie Unica

- 1 ■ Perfect geschikt voor renovatie dankzij de aansluiting van slechts 100 mm.
■ Parfaitement adapté à la rénovation grâce au raccordement de seulement 100 mm.
■ Perfectly suitable for renovation thanks to the connection of only 100 mm.
■ Perfetta per una ristrutturazione grazie allo scarico di soli 100 mm.

- 2 ■ Het open systeem maakt het ideaal in renovatie-situaties.
■ Le système atmosphérique le rend idéal dans des situations de rénovation.
■ The open system makes it ideal for renovation projects.
■ Il sistema "aperto" fa in modo che sia ideale per interventi di ristrutturazione.

- 3 ■ De minimale diepte van 35 cm, biedt extra inbouwvrijheid.
■ La profondeur minimale de 35 cm offre une liberté d'encastrement supplémentaire.
■ The minimum depth of 35 cm offers additional freedom in building it in.
■ La profondità minima di 35 cm offre maggiore libertà di incasso.

- 4 ■ Optionele sfeerverlichting geeft extra vuurbeleving.
■ L'éclairage d'ambiance en option optimise l'expérience du feu.
■ The ambiance lighting provides added enjoyment of the fire.
■ L'illuminazione d'ambiente opzionale offre una visuale del fuoco ed un'esperienza ancora più coinvolgente.

- 5 ■ Extra stookcomfort met de optionele convectieventilator.*
■ Confort supplémentaire avec le ventilateur de convection en option.*
■ Additional burning comfort with the optional convection fan.*
■ Calore molto confortevole grazie al ventilatore di convezione.*

- 6 ■ Altijd passend, door de verschillende klassieke kaders.
■ Se marie toujours bien grâce aux différents cadres classiques.
■ Always suitable due to the various classic frames.
■ Le varie cornici classiche lo rendono versatile e adatto a qualsiasi tipo di arredamento.

- 7 ■ Eenvoudig in onderhoud, alle techniek is van voren te bereiken.
■ Facile à entretenir, toute la technique étant accessible par l'avant.
■ Easy to maintain, all the technical parts can be reached from the front side.
■ Di facile manutenzione dato che tutti i comandi sono accessibili dalla parte anteriore.

- 8 ■ Bedieningsgemak door standaard bediening met handzender.
■ Manipulation aisée par la télécommande de standard.
■ Easy to operate using a standard remote control.
■ Massima comodità d'uso grazie al funzionamento con telecomando.

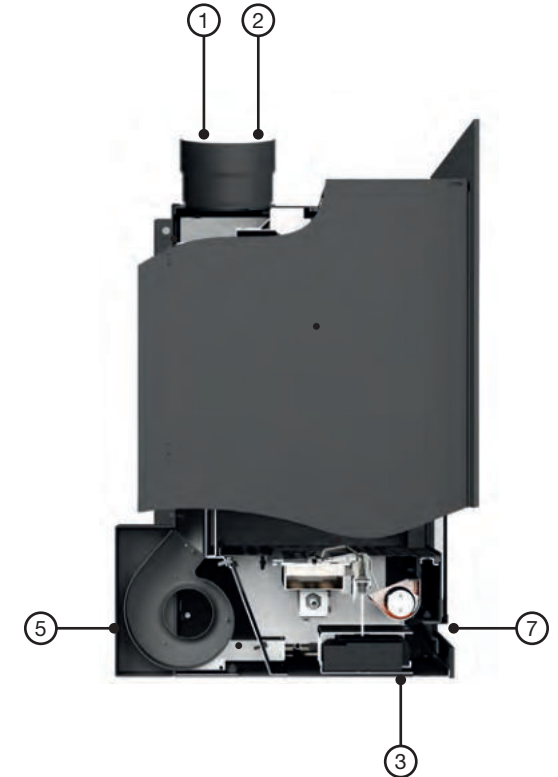

* Let op: 4 cm extra inbouwdiepte. | Veuillez noter: profondeur d'installation supplémentaire de 4 cm. | Note: 4 cm extra installation depth. | Nota: profondità di installazione extra di 4 cm.



Renovatie

Rénovation | Renovation | Ristrutturazioni

■ Zeer geschikt bij renovatie

Speciaal voor de renovatiemarkt levert Bellfires een aantal zogeheten inzethaarden. Deze haarden passen door hun afmetingen en kadervarianten in praktisch elke bestaande situatie. Dit wordt mede mogelijk gemaakt door allerlei technische snufjes. Zo zijn ze van binnenuit aan te sluiten en hebben ze geen bedieningsluikje nodig. De maatvoering van deze toestellen is speciaal afgestemd op de meest voorkomende maten van bestaande open haarden. Dit geeft nieuw vuur in een bestaande situatie. Je herkent deze inzethaarden aan het “extra-geschikt-voor-renovatie” logo.

■ Particulièrement adaptés à la rénovation

Spécialement pour le marché de la rénovation, Bellfires propose plusieurs inserts. Grâce à leurs dimensions et différents cadres, ces appareils s'adaptent pratiquement à chaque situation existante. Cela est également possible grâce à toutes sortes de gadgets techniques. C'est ainsi qu'ils peuvent être raccordés de l'intérieur et qu'aucune trappe d'accès n'est requise. Les dimensions de ces appareils sont spécialement adaptées aux tailles les plus courantes des âtres ouverts existants. Cela permet de créer un nouveau feu dans une situation existante. Ces inserts sont reconnaissables au logo “particulièrement adapté à la rénovation”.

■ Very suitable for renovation

Bellfires supplies a number of insert fireplaces specifically for the renovation market. Due to their dimensions and variety of frames, these fireplaces fit into practically any existing situation. This is also made possible by the use of all sorts of technical innovations. For example, they can be connected at the inside and they do not need a control hatch. The dimensions of these appliances are specifically coordinated to the most common dimensions of existing open fireplaces. This provides a new fire in an existing situation. You can recognise these insert fireplaces by the “extra-suited for renovation” logo.

■ Particolarmente adatto per interventi di ristrutturazione

Bellfires offre alcuni camini cosiddetti da inserto appositamente studiati per il settore delle ristrutturazioni. Questi camini, grazie alle loro dimensioni e varianti di cornici, si adattano a praticamente qualsiasi situazione esistente. Tutto ciò è possibile grazie alle ingegnose soluzioni adottate. Ad esempio è possibile collegare il caminetto dall'interno e non vi è necessità di un pannello di controllo. Le dimensioni di questi dispositivi sono appositamente studiate per rispettare le dimensioni più comuni dei camini aperti esistenti. In questo modo è possibile installare un apparecchio nuovo in una situazione esistente. È possibile riconoscere questi camini da inserto dal logo “particolarmente-adatto-per-ristrutturazioni”



Convectie ventilator

Ventilateur de convection | Convection fan | Ventilatore ambiente

■ Krachtige ventilator

Enkele van onze haarden kunnen optioneel voorzien worden van een krachtige ventilator die zorgt voor een snelle verspreiding van de warmte in de ruimte. Deze regelbare ventilator bevindt zich onder of in het toestel. Afhankelijk van het type haard kan deze ventilator uitgeschakeld worden.

■ Ventilateur puissant

Plusieurs de nos appareils peuvent être équipés en option d'un ventilateur puissant qui assure une diffusion rapide de la chaleur dans la pièce. Ce ventilateur réglable se trouve en dessous ou à l'intérieur de l'appareil. Selon le type d'appareil, ce ventilateur peut être éteint.

■ Powerful fan

Some of our fireplaces can be optionally equipped with a powerful fan system that ensures heat is spread rapidly throughout the room. This adjustable fan is located underneath or inside the appliance. Depending on the type of fireplace, this fan can be switched off.

■ Sistema di ventilazione potente

Alcuni dei nostri camini possono essere dotati come optional di una potente ventola che garantisce una rapida diffusione del calore nell'ambiente. La ventola regolabile si trova sotto o all'interno dell'apparecchio. In base al modello di camino, la ventola può anche essere spenta.



Gassoorten

Types de gaz | Gas types | Tipi di gas

■ Gassoorten

Al onze haarden zijn voorzien van de modernste techniek. Dat betekent dat ze over een prachtig, betoverend vuurbeeld beschikken en ook nog eens goed voorbereid zijn op de toekomst. Zo zijn al onze gashaarden gekeurd voor de nieuwste gassoorten. En daarnaast is het ook mogelijk om onze haarden van de ene naar de andere gassoort om te bouwen. Bijvoorbeeld van aardgas naar propaan.

Daarom zijn onze haarden dus niet alleen voorzien van het mooiste vuurbeeld maar ook nog eens toekomstbestendig. Heb je vragen over de verschillende mogelijkheden? Jouw dealer weet er alles van en vertelt hier graag meer over.

■ Types de gaz

Tous nos appareils intègrent des techniques dernier cri. Ils offrent donc non seulement une vue formidable et ensorcelante sur les flammes, mais sont également parfaitement parés pour l'avenir. C'est ainsi que tous nos appareils au gaz sont homologués pour les derniers types de gaz. De plus, il est également possible de transformer nos appareils d'un type de gaz à un autre. Par exemple du gaz naturel au propane ou vice versa.

Nos foyers offrent donc non seulement la plus jolie vue sur les flammes, mais résistent également à l'épreuve du temps. Vous avez des questions sur les différentes possibilités ? Votre revendeur se fera un plaisir de vous en dire plus.

■ Gas types

All our fireplaces feature the latest technology. This means that they provide a beautiful and magical fire display and they are manufactured with the future in mind. All our gas fireplaces are approved for the latest gas types. Furthermore, they can be refitted to switch from one type of gas to another e.g., from natural gas to propane.

That is why our fireplaces not only provide the nicest flame image, but they are also future-proof. Any questions about the various possibilities? Your dealer knows everything about our products and will be pleased to help you.

■ Tipi di gas

Tutti i nostri camini sono dotati delle più moderne tecnologie. Questo significa che oltre a sprigionare fiamme ammalianti restituendo un meraviglioso aspetto del fuoco, essi sono pronti ad accogliere le tecnologie del futuro. Infatti, i nostri camini a gas sono certificati per i più recenti tipi di gas. Inoltre è possibile adattare i nostri camini da un tipo di gas all'altro. Ad esempio da gas naturale a propano.

I nostri camini non hanno solo una fiamma affascinante ma dispongono anche di una tecnologia all'avanguardia. Volete conoscere in dettaglio le varie possibilità? Il vostro rivenditore sarà lieto di rispondere a tutte le domande.



Afstandsbediening en WiFi

Télécommande et Wi-Fi | Remote control and WiFi | Telecomando e WiFi

■ Al onze haarden zijn standaard uitgerust met de nieuwste generatie Symax afstandsbedieningen. Deze afstandsbedieningen bieden volop gebruiksgemak doordat elke functie een eigen knop heeft. Dit maakt het bedienen van je gashaard kinderlijk eenvoudig.

Je kunt eventueel ook kiezen voor een WiFi-module. Dan kun je de haard bedienen met behulp van je tablet of smartphone. Bij het gebruik kun je kiezen voor WiFi en een handzender of je kiest voor de puck. De puck is een vereenvoudigde afstandsbediening waarmee je in combinatie met de Bellfires-app alle functionaliteiten kunt bedienen.

■ Tous nos appareils sont équipés de série de la dernière génération de télécommandes Symax. Ces télécommandes sont très faciles à utiliser grâce au bouton spécifique attribué à chaque fonction. Ainsi, commander votre appareil au gaz devient un jeu d'enfant.

Vous pouvez éventuellement aussi opter pour un module Wi-Fi. Ainsi, vous pouvez commander l'appareil avec votre tablette ou smartphone. Pour l'utilisation, vous avez le choix entre le Wi-Fi avec émetteur manuel ou le puck. Le puck est une télécommande simplifiée vous permettant de commander toutes les fonctionnalités en combinaison avec l'application Bellfires.

■ All our fireplaces are standard equipped with the latest generation Symax remote controls. These remote controls are very easy to use because each function has its own button. This makes the operation of your gas fireplace very simple.

You may also opt for a WiFi module, which enables you to operate your fireplace using your tablet or smartphone. When selecting WiFi, you can choose either a remote control or a puck. The puck is a simplified remote control that offers all the functions when combined with the Bellfires-app.

■ Tutti i nostri camini hanno di serie i telecomandi Symax di ultima generazione. Questi telecomandi offrono una grande facilità di uso e di controllo grazie al fatto che ogni funzione ha un pulsante apposito. Questo rende il controllo del vostro camino a gas incredibilmente semplice.

E' disponibile anche un modulo WiFi. Che vi permetterà di gestire il camino direttamente dal vostro smartphone o tablet. Puoi scegliere di gestire il tuo camino tramite WiFi con telecomando o con "disco". Il "disco" è un telecomando semplificato con cui è possibile controllare tutte le funzioni in combinazione con l'applicazione Bellfires.



- Afstandsbediening en puck
- Télécommande et puck
- Remote control and puck
- Telecomando e disco

Overzicht schakelbare branders

Vue d'ensemble des brûleurs modulables | Overview of switchable burners | Panoramica bruciatori



Line Fire

■ Line Fire

Als je beide branders inschakelt geef je extra diepte en sfeer aan het vlambeeld. In de spaarstand brandt alleen de voorste brander, maar dan wél over de volledige breedte van de haard. Hiermee bespaar je op gasverbruik en heb je minder warmteafgifte.

■ Line Fire

Les deux brûleurs allumés confèrent une profondeur et une ambiance supplémentaires aux flammes. En position économique, il n'y a que le brûleur avant qui est actif, mais il l'est sur toute la largeur de l'appareil.

■ Line Fire

If you switch on both burners, you give the flame image extra depth and atmosphere. In the save position, only the front burner burns, but over the entire length of the fireplace. This saves on gas consumption and reduces the heat output.

■ Line Fire

Accendendo entrambi i bruciatori la fiamma ha una profondità maggiore ed una fiamma più intensa. In modalità risparmio energetico si accenderà solo il bruciatore frontale, ma le sue fiamme occuperanno tutta la larghezza del camino. Con questo sistema potrete risparmiare sul consumo di gas, ottenendo un minor rilascio di calore.

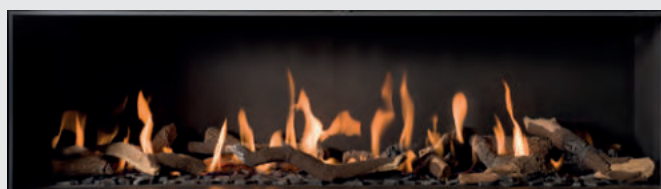

- Beide branders aan
- Les deux brûleurs allumés
- Both burners on
- Entrambi I bruciatori sono accesi

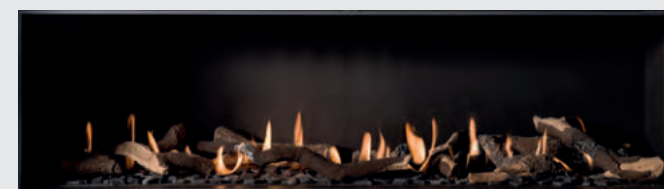

- In spaarstand; alleen voorste brander aan
- En position économique; seul le brûleur de devant est allumé
- In the power saving mode; only the front burner on
- Nella modalità risparmio energetico, solo il bruciatore frontale è acceso



Centre Fire

■ Centre Fire

Bij dit type varieer je het vuurbeeld in de breedte. Twee branders geven de gashaard een warm vuur over de volledige breedte van de haard. In de spaarstand brandt het vuur alleen in het midden van de haard. Hiermee bespaar je op gasverbruik en heb je minder warmteafgifte.

■ Centre Fire

De cette manière, le feu peut être réglé en largeur. Avec deux brûleurs, l'appareil au gaz offre un feu chaleureux sur toute la largeur de l'appareil. En position économique, seul le brûleur du milieu est allumé.

■ Centre Fire

This type allows you to vary your flame image in the width. Two burners give the gas fireplace a warm fire over the entire width of the fireplace. In the save position, the fire burns only in the middle of the fireplace. This saves on gas consumption and reduces the heat output.

■ Centre Fire

Con questo tipo potete regolare l'ampiezza dell'aspetto del fuoco. Due bruciatori danno vita ad un fuoco caldo e vivace su tutta la larghezza del camino a gas. In modalità risparmio energetico il fuoco occuperà solo il centro del camino. Con questo sistema potrete risparmiare sul consumo di gas, ottenendo un minor rilascio di calore.

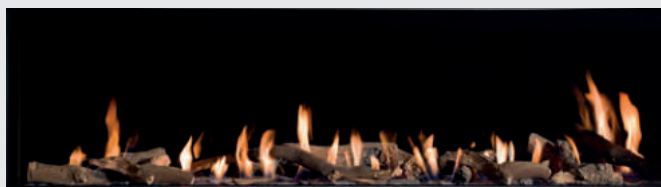

- Beide branders aan
- Les deux brûleurs allumés
- Both burners on
- Entrambi I bruciatori sono accesi

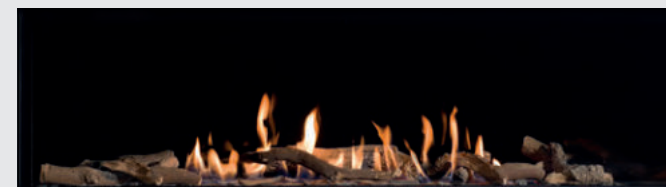

- In spaarstand; alleen middelste brander aan
- En position économique, seul le brûleur du milieu est allumé
- In the power saving mode; only the front burner on
- Nella modalità risparmio energetico, solo il bruciatore frontale è acceso

Overzicht schakelbare branders

Vue d'ensemble des brûleurs modulables | Overview of switchable burners | Panoramica bruciatori



MagniFire

■ Trapsgewijs spelen met vuur

Met de MagniFire kun je in een 'lager' toestel een 3D vuurbeeld creëren. Door de schakelbaarheid van deze brander kun je besparen op je gasverbruik en heb je minder warmteafgifte. Deze brander leveren wij standaard met sfeerverlichting, voor de levensechte vuurbeleving.

■ Jouer par paliers avec le feu

Avec le MagniFire, vous pouvez créer un jeu de flammes en 3D même dans un appareil 'moins haut'. Nous livrons ce brûleur en standard avec un éclairage d'ambiance, pour une expérience du feu plus vraie que nature.

■ Step by step, playing with fire

The MagniFire can create a 3D flame image in a 'lower' appliance. The feature of switchability in this burner lets you save on gas consumption and reduces the heat output. This burner is standard supplied with ambient lighting for a lifelike fireplace experience.

■ Giocare con i livelli del fuoco

Con il MagniFire puoi creare un'immagine del fuoco 3D anche in un caminetto dall'altezza ridotta. Grazie alla regolazione di questo bruciatore potrete risparmiare sul consumo di gas, ottenendo un minor rilascio di calore. Questo bruciatore viene fornito di serie con un'illuminazione d'ambiente, per un'esperienza coinvolgente e realistica del fuoco.

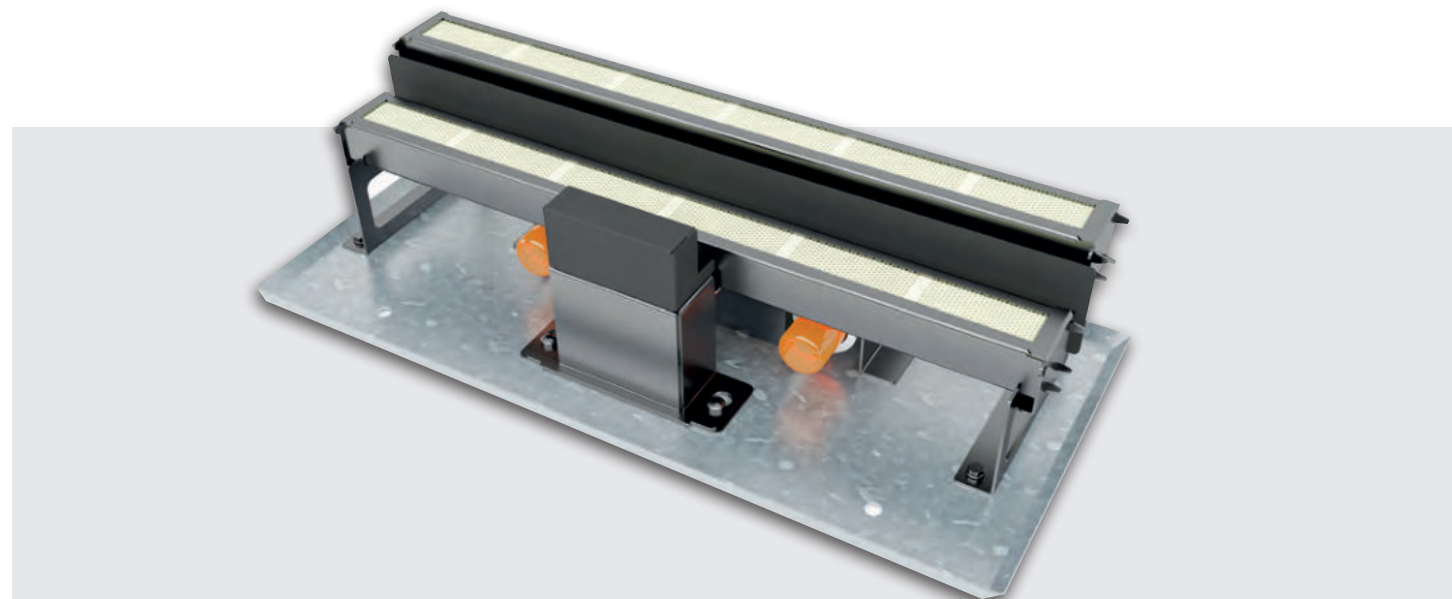

- Beide branders aan
- Les deux brûleurs allumés
- Both burners on
- Entrambi i bruciatori sono accesi



- In spaarstand; alleen voorste brander aan
- En position économique; seul le brûleur de devant est allumé
- In the power saving mode; only the front burner on
- Nella modalità risparmio energetico, solo il bruciatore frontale è acceso



- Sfeerverlichting met vlammen
- Éclairage d'ambiance avec les flammes
- Ambient lighting with flames
- Illuminazione dell'ambiente con fiamme

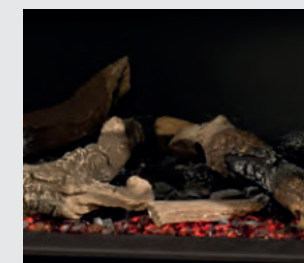

- Sfeerverlichting zonder vlammen
- Éclairage d'ambiance sans les flammes
- Ambient lighting without flames
- Illuminazione dell'ambiente senza fiamme



Premium Fire

■ Nét echt

Een houtvuur in je kamer dankzij drie branders die in houtstammen verwerkt zijn. De voordelen van een dubbele gasbrander worden gecombineerd met de warme sfeer van een levensecht kampvuur. Door de schakelbaarheid van deze brander kun je besparen op je gasverbruik en heb je minder warmteafgifte.

■ Si réaliste

Un feu de bois dans votre pièce grâce à trois brûleurs intégrés dans des bûches. Premium Fire combine les avantages d'un double brûleur à gaz avec l'ambiance chaleureuse d'un véritable feu de camp.

■ Almost real

A wood fire in your room thanks to three burners incorporated into the logs. The advantages of a double gas burner are combined with the warm ambiance of a lifelike campfire. The feature of switchability in this burner lets you save on gas consumption and reduces the heat output.

■ Come un vero fuoco

A legna nella vostra casa grazie ai tre bruciatori incorporati nei ceppi di legno. I vantaggi di un bruciatore gas doppio combinati alla calda atmosfera regalata da un falò. Grazie alle regolazioni di questo bruciatore potrai risparmiare sul consumo di gas, ottenendo un minor rilascio di calore.

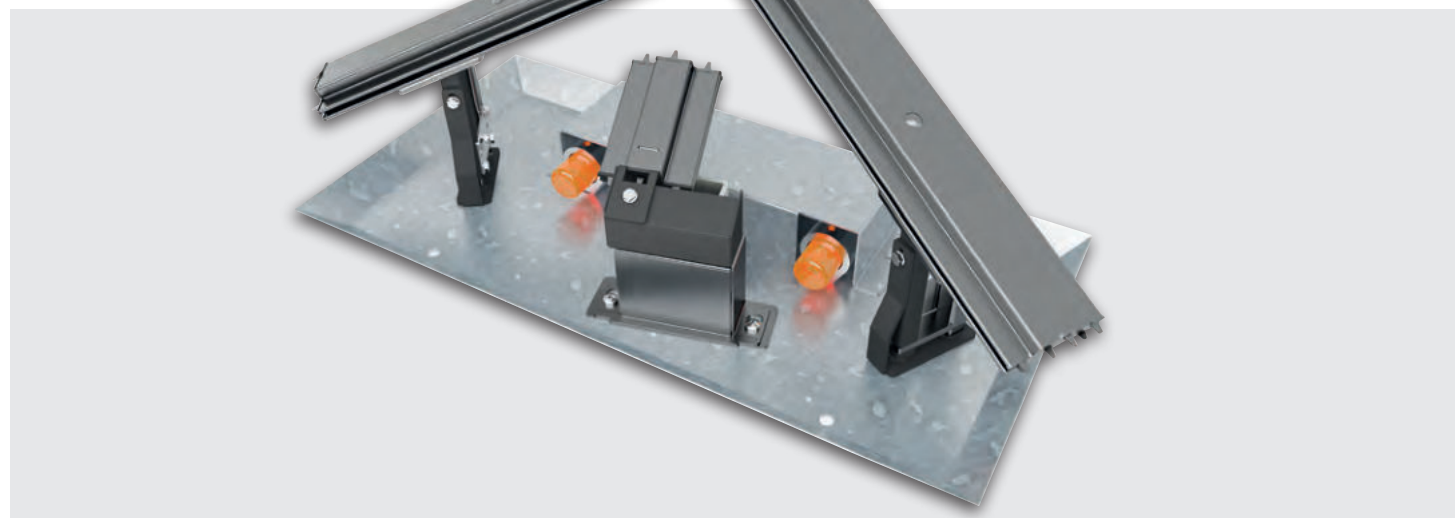

- Beide branders aan
- Les deux brûleurs allumés
- Both burners on
- Entrambi i bruciatori sono accesi

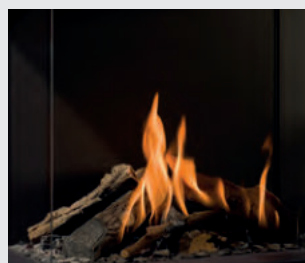

- In spaarstand; alleen voorste brander aan
- En position économique; seul le brûleur de devant est allumé
- In the power saving mode; only the front burner on
- Nella modalità risparmio energetico, solo il bruciatore frontale è acceso



- Sfeerverlichting met vlammen
- Éclairage d'ambiance avec les flammes
- Ambient lighting with flames
- Illuminazione dell'ambiente con fiamme



- Sfeerverlichting zonder vlammen
- Éclairage d'ambiance sans les flammes
- Ambient lighting without flames
- Illuminazione dell'ambiente senza fiamme

Overzicht schakelbare branders

Vue d'ensemble des brûleurs modulables | Overview of switchable burners | Panoramica bruciatori



MagniFire Flow

■ Maximaal vuurbeeld

De MagniFire Flow varieert in hoogte en diepte voor een maximaal vuurbeeld rondom. Door de schakelbaarheid van deze brander kun je besparen op je gasverbruik en heb je minder warmteafgifte. Deze brander leveren wij standaard met sfeerverlichting, voor de levensechte vuurbeleving.

■ Expérience de feu incroyable

Le MagniFire Flow varie en hauteur et en profondeur pour une optimisation de la vision du feu. Nous livrons ce brûleur en standard avec un éclairage d'ambiance, pour une expérience du feu plus vraie que nature.

■ Maximum fire image

The MagniFire Flow varies in height and depth for a maximum fire image all round. The feature of switchability in this burner lets you save on gas consumption and reduces the heat output. This burner is standard supplied with ambient lighting for a lifelike fireplace experience.

■ Immagine massima del fuoco

MagniFire Flow varia in altezza e profondità per una immagine perfetta del fuoco a tutto tondo. La versatilità di questo bruciatore consente di risparmiare sul consumo di gas e riduce la potenza termica senza compromettere l'esperienza di fuoco. Questo bruciatore viene fornito con il sistema "m bianche lighting" per un'esperienza realistica e coinvolgente del fuoco.

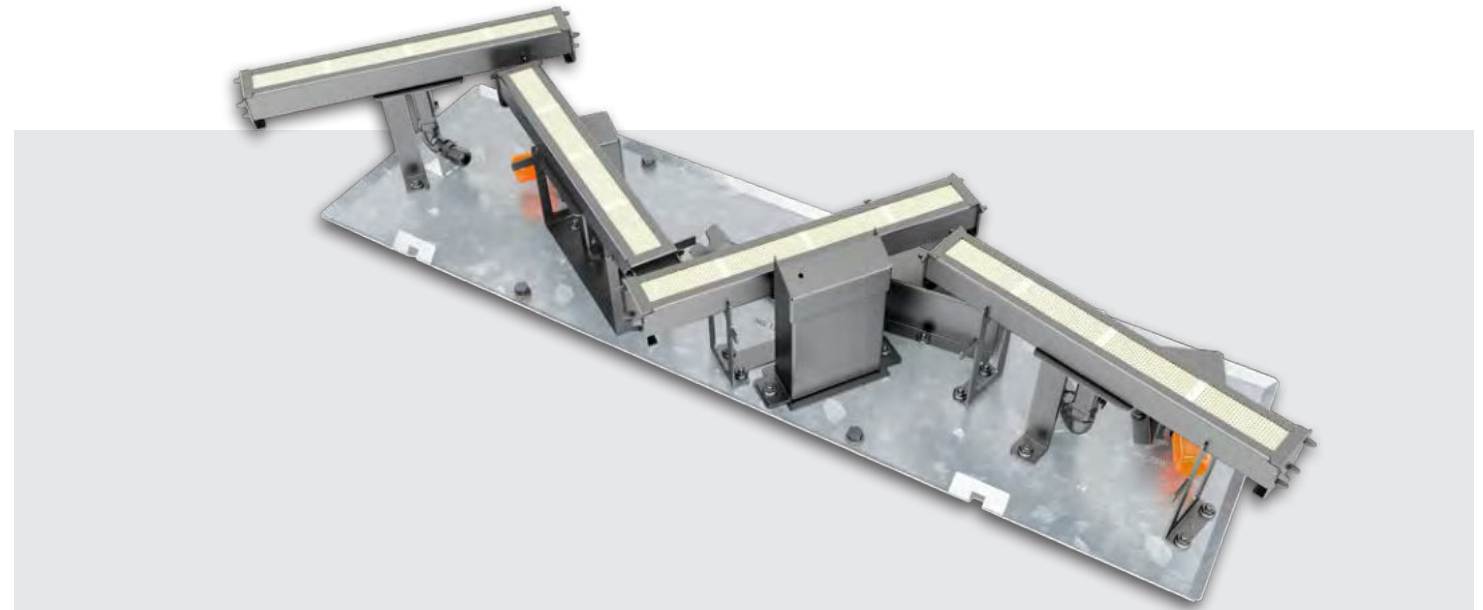

- Beide branders aan
- Les deux brûleurs allumés
- Both burners on
- Entrambi I bruciatori sono accesi



- In spaarstand; alleen voorste brander aan
- En position économique; seul le brûleur de devant est allumé
- In the power saving mode; only the front burner on
- Nella modalità risparmio energetico, solo il bruciatore frontale è acceso



- Sfeerverlichting zonder vlammen
- Éclairage d'ambiance sans les flammes
- Ambient lighting without flames
- Illuminazione dell'ambiente senza fiamme





Interieur

Intérieurs | Interior | Interni



- Classic Bell:
- Dakpannen interieur rood
 - Intérieur rustique en briquettes rouges
 - Rustic brick interior red
 - Interno con mattoncini rosso



- Classic Bell:
- Dakpannen interieur grijs
 - Intérieur rustique en briquettes grises
 - Rustic brick interior grey
 - Interno con mattoncini grigio



- Classic Bell:
- Dakpannen interieur geel
 - Intérieur rustique en briquettes jaunes
 - Rustic brick interior yellow
 - Interno con mattoncini giallo



Smart Bell Panorama:

- Industrial interior
- Industrial interior
- Industrial interior
- Industrial interior



Original Bell - serie:

- Lamellen
- Lamelles en acier
- Steel panels
- Pannelli in acciaio



Unica - / Smart Bell - / Original Bell - serie:

- Zwart keramische spiegelwand
- Miroir céramique noir
- Ceramic black mirror interior
- Parete a specchio



Unica - / Smart Bell - / Original Bell - serie:

- Vlakke wand
- Paroi lisse
- Plain background
- Fondo liscio



Brander decoratie

Décorations de brûleur | Burner decoration | Decorazione bruciatori



- Houtstammen
- Bûches céramiques
- Wood logs
- Tronchetti



- Witte kiezels
- Cailloux blancs
- White marble shingles
- Ciottoli di marmo bianco



- Grijs kiezels
- Cailloux gris
- Grey stones
- Ciottoli grigi



Overzicht kaders

Vue d'ensemble des cadres | Overview of frames | Panoramica cornici



- Smart Bell:
- Klassiek kader - 35 mm
 - Cadre classique - 35 mm
 - Classic frame - 35 mm
 - Cornice classic - 35 mm



- Smart Bell:
- Klassiek kader - 70 mm
 - Cadre classique - 70 mm
 - Classic frame - 70 mm
 - Cornice classic - 70 mm



- Smart Bell:
- Klassiek kader - 52 mm
 - Cadre classique - 52 mm
 - Classic frame - 52 mm
 - Cornice classic - 52 mm



- Smart Bell:
- Inbouw kader
 - Cadre encastrable
 - Built-in frame
 - Cornice built-in



Overzicht kaders

Vue d'ensemble des cadres | Overview of frames | Panoramica cornici



- Smart Bell:
- Verdiept kader - 15 mm
 - Cadre de profondeur - 15 mm
 - Insert frame - 15 mm
 - Cornice insert - 15 mm



- Unica:
- 4-zijdig kader 35 mm
 - Cadre 4 faces 35 mm
 - 4-side frame 35 mm
 - Cornice a 4 lati 35 mm



- Smart Bell:
- Verdiept kader - 50 mm
 - Cadre de profondeur - 50 mm
 - Insert frame - 50 mm
 - Cornice insert - 50 mm



- Unica:
- 4-zijdig kader 70 mm
 - Cadre 4 faces 70 mm
 - 4-side frame 70 mm
 - Cornice a 4 lati 70 mm



Original Bell:

- Hidden Door
- Hidden Door
- Hidden Door
- Hidden Door



Original Bell:

- Floating Frame
(Optioneel inclusief AR-glas)
- Floating Frame
(En option avec vitre anti-reflet)
- Floating Frame
(Optionally including anti-reflective glass)
- Floating Frame
(vetro antiriflesso disponibile a richiesta)



Original Bell:

- Hidden Door +7 cm
- Hidden Door +7 cm
- Hidden Door +7 cm
- Hidden Door +7 cm



Original Bell:

- Hidden Door +10 cm
- Hidden Door +10 cm
- Hidden Door +10 cm
- Hidden Door +10 cm



Overzicht kaders

Vue d'ensemble des cadres | Overview of frames | Panoramica cornici



- Original Bell:
- Hidden Door +10 cm & stenen balk
 - Hidden Door +10 cm & rebord en pierre
 - Hidden Door +10 cm & stone bar
 - Hidden Door +10 cm & soglia in pietra



- Original Bell:
- Hidden Door +10 cm
 - Hidden Door +10 cm
 - Hidden Door +10 cm
 - Hidden Door +10 cm



- Original Bell:
- Hidden Door
 - Hidden Door
 - Hidden Door
 - Hidden Door



- Room Divider:
- Kaderloos
 - Sans cadre
 - Frameless
 - Senza cornice

Opti-Vent

Frans | Engels | Italiaans

- Wilt u zelf kiezen waar u uw gashaard plaatst en niet meer afhankelijk zijn van bestaande rookkanalen? Dat kan!
Dankzij de nieuwe Opti-Vent van Bellfires kunt u op elke gewenste plek in uw woning een haard plaatsen. De Opti-Vent is een mechanisch gereguleerd rookgassysteem en biedt daardoor meer vrijheid.
- Voulez-vous choisir vous-même où placer votre foyer au gaz et ne plus dépendre des conduits de fumée existants ? C'est possible !
Grâce au nouveau Opti-Vent de Bellfires, vous pouvez placer un foyer où vous le voulez dans votre maison. L'Opti-Vent est un système d'évacuation de gaz de combustion à réglage mécanique et donc offre plus de liberté.
- Would you like to make your own choice about where to put your gas fire and not be dependent on an existing chimney?
The choice is yours!
Thanks to Bellfires' new Opti-Vent you can put the gas fire anywhere in your home where ever you desire. Opti-Vent is a mechanically regulated smoke outlet system, so it gives you much more freedom.
- Ti piacerebbe scegliere dove mettere il tuo caminetto a gas e non dipendere dalla posizione della canna fumaria esistente? La scelta è tua!
Grazie al nuovo Opti-Vent di Bellfires puoi installare il tuo caminetto a gas ovunque desideri nella casa. Opti-Vent ti dà anche più libertà di progettazione su dove posizionare l'intera unità. Opti-Vent è un sistema di uscita del fumo regolato meccanicamente e ti dà molta più libertà.

■ Voordelen van de Opti-Vent:

- Veel vrijheid voor de positie van de haard in de ruimte en de rookgasafvoer naar de buitenzijde van uw woning
- Mogelijk voor zowel aardgas als propaan
- Volledig mechanisch en zelf regulerend systeem
- Mogelijk om te werken met een kleiner kanaal

■ Les avantages de l'Opti-Vent :

- Beaucoup de liberté pour la position du foyer dans la pièce et l'évacuation des fumées vers l'extérieur de votre maison
- Possibilité pour le gaz naturel et le propane
- Système entièrement mécanique et autorégulé
- Possibilité d'utiliser un conduit plus petit

■ Advantages of Opti-Vent:

- More freedom in placing the gas fire in the room, with the smoke outlet on the outside of your house
- Suitable for both natural gas and propane
- Fully mechanical, self-regulating system
- Accommodates a smaller exhaust pipe

■ Vantaggi di Opti-Vent:

- più libertà nel posizionare il tuo caminetto a gas nella stanza, con l'uscita del fumo all'esterno della tua casa.
- Adatto sia per gas naturale che per il propano
- Sistema completamente meccanico e autoregolante
- Accoglie un tubo di scarico di diametro ridotto

Beluchtingsrooster

Grilles de ventilation | Aeration grid | Griglia di aerazione

- Wij bieden voor ventilatie openingen de keuze uit design roosters die verdwijnen in de ombouw of juist opvallen.
- Pour les ouvertures de ventilation, nous offrons un choix de grilles design qui disparaissent dans l'enveloppe ou qui, au contraire, sautent aux yeux.
- For ventilation openings, we offer a choice of design grids that are out of sight in the housing or just the opposite: they stand out.
- Per le aperture di ventilazione, potete scegliere tra griglie di design interamente incorporate nell'aspetto del camino o, al contrario, che siano in risalto.

■ Beluchtingsrooster

Voor een goede werking van de haard is het belangrijk dat de ombouw, bij een niet massieve schouw, altijd wordt verlucht. Dit gebeurt door ventilatie openingen aan de onder en bovenzijde van de ombouw aan te brengen.

Wij leveren hiervoor specifieke design roosters. Daarnaast kunnen onze toestellen worden uitgerust met een convectieset voor extra convectiewarmte. Wil je advies over onze roosters of het toepassen van een convectieset?

De dealer helpt je graag verder. De roosters bestaan uit twee maten. Je kunt kiezen voor 160 mm of 320 mm.

Al onze roosters zijn leverbaar in 2 verschillende kleuren: wit of grafietzwart.

■ Grilles de ventilation

Pour garantir le bon fonctionnement du foyer quand il est mis dans un coffrage, il est important que celui-ci ait été correctement ventilé. Nous proposons pour cela des grilles design spécifiques. De plus, nos appareils peuvent être équipés d'un kit de convection pour augmenter la chaleur de convection.

Vous désirez un conseil sur nos grilles ou sur l'utilisation d'un kit de convection ? Votre revendeur se fera un plaisir de vous aider.

Les grilles se déclinent en deux tailles, 160 ou 320 mm.

Toutes nos grilles sont disponibles en 2 couleurs différentes : blanc ou noir graphite.

■ Aeration grid

To ensure correct operation of the fireplace when creating a false chimney breast, it is important that it has been properly ventilated. This occurs by installing ventilation openings at the bottom or top side of the housing. We supply specific design grids. In addition, our appliances can be fitted with a convection set for extra convection heat. If you want additional advice about our grids or how to apply a convection set, then your dealer can help you with that.

The grids come in two sizes. You can choose between 160 mm or 320 mm.

All our grids are available in 2 different colours: white or graphite black.

■ Griglia di aerazione

Per garantire il corretto funzionamento del caminetto, è necessario che la controparete sia adeguatamente ventilata. Per far ciò è necessario apportare delle aperture nella parte superiore e inferiore della struttura. A questo scopo forniamo griglie di design specifiche.

Inoltre i nostri dispositivi sono dotati di un set di convezione per ottenere ancora più calore. Avete bisogno di consigli sulle nostre griglie o sull'applicazione di un set di convezione?

Il vostro rivenditore vi aiuterà con grande piacere. Le griglie sono disponibili in due misure. Potete scegliere tra una griglia da 160 mm o da 320 mm.

Tutte le nostre griglie sono disponibili in 2 colori: bianco o nero.

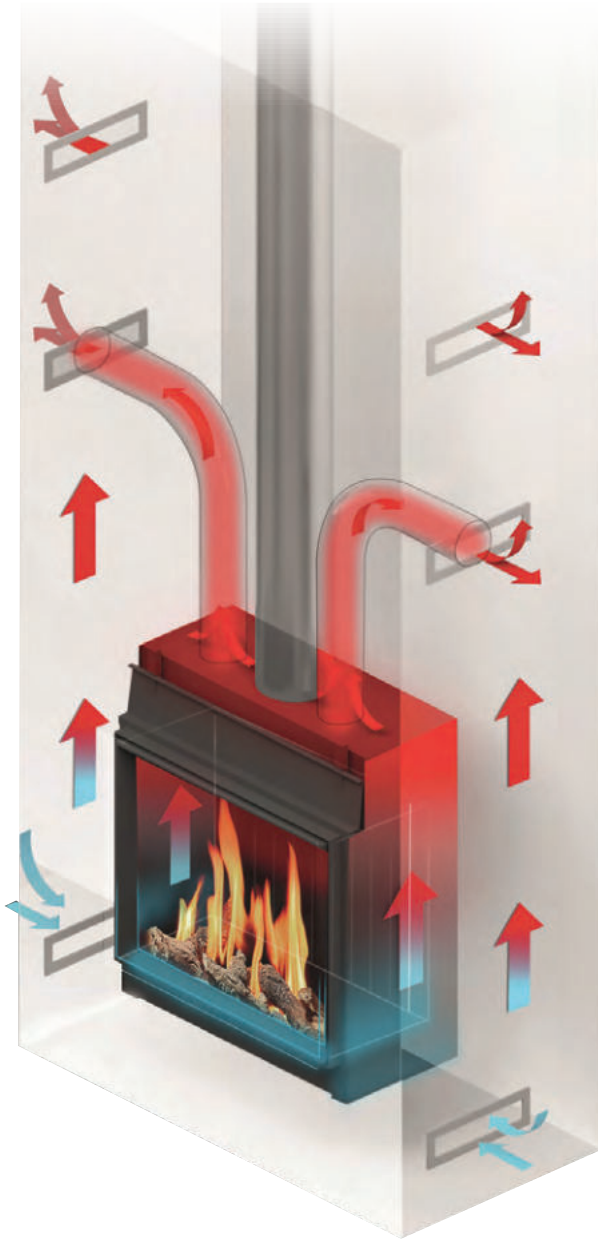

- Kaderloos
- Sans cadre
- Frameless
- Senza cornice



- Inbouw kader
- Cadre encastrable
- Built-in frame
- Cornice ad incasso



- Slim kader
- Cadre fin
- Slim frame
- Cornice sottile



- Klassiek kader
- Cadre classique
- Classic frame
- Cornice classica

Service en garantie

Service et garantie | Service and warranty | Assistenza e garanzia

■ Een tophaard van Bellfires verdient de allerbeste service. Jouw dealer zal een eventuele storing zo snel mogelijk verhelpen, zo nodig ondersteund door het Bellfires-serviceteam. Bellfires geeft 10 jaar garantie op de romp van het toestel en 2 jaar op onderdelen. Voor verbruiksonderdelen geven wij eenzelfde garantie tot na de eerste stook. Bellfires garandeert dat vitale onderdelen nog minimaal 10 jaar na stopzetten van de productie leverbaar blijven.

Onze haarden worden uitsluitend geleverd via een netwerk van deskundige Bellfires dealers die garant staan voor een verantwoorde en veilige installatie. Tot in lengte van dagen genieten van jouw haardvuur? Laat dan jouw dealer jaarlijks onderhoud aan de installatie verrichten.

■ Un appareil haut de gamme Bellfires mérite ce qu'il y a de mieux en matière de service. C'est la raison pour laquelle votre revendeur agréé réparera le plus vite possible une panne éventuelle, le cas échéant soutenu par l'équipe technique du service Bellfires. Bellfires accorde 10 ans de garantie sur la structure de votre appareil (hors peinture) et 2 ans sur l'ensemble des autres pièces et mécanismes. Pour les pièces sujettes à usure (voir notices) et pour la vitre, la garantie s'achève dès la première utilisation. Bellfires garantit que les pièces nécessaires au bon fonctionnement de votre appareil resteront disponibles et livrables pendant au moins 10 ans après l'arrêt de la production.

Nos appareils sont livrés exclusivement par le biais d'un réseau de revendeurs Bellfires compétents, qui garantissent une installation responsable et sûre. Vous voulez profiter plus longtemps de votre cheminée ? Confiez l'entretien annuel de l'installation à votre revendeur.

■ A top fireplace of Bellfires deserves the very best service. Your dealer will help you with any failure as fast as possible, if necessary, assisted by a Bellfires Service Team. Bellfires gives you a 10-year warranty on the body of the appliance and 2 years on the parts. For consumables, we give the same warranty up to the first burning of the appliance. Bellfires guarantees that vital parts will be available at least 10 years after the production of the model has stopped.

Our fireplaces are supplied only via a network of professional Bellfires dealers who guarantee responsible and safe installation. Want to enjoy your fireplace without end? Then let your dealer carry out an annual maintenance to your appliance.

■ Un camino Bellfires si merita la migliore assistenza. Il rivenditore risolverà eventuali problemi il più rapidamente possibile, supportato, se necessario dal team di assistenza Bellfires. Bellfires offre 10 anni di garanzia sulla struttura del camino e 2 anni sui componenti. Per i materiali di consumo offriamo la stessa garanzia fino alla prima accensione. Bellfires garantisce che i pezzi vitali rimarranno disponibili per almeno 10 anni dopo l'interruzione della produzione.

I nostri camini vengono forniti esclusivamente attraverso una rete di rivenditori esperti di Bellfires che garantiscono un'installazione responsabile e sicura. Volete godervi il vostro camino in tutta tranquillità e per lungo tempo? Fate eseguire la manutenzione annuale al vostro rivenditore.



Schets hier je ideeën!

Esquisser vos idées ici! | Sketch your ideas here! | Dai forma alle tue idee qui!

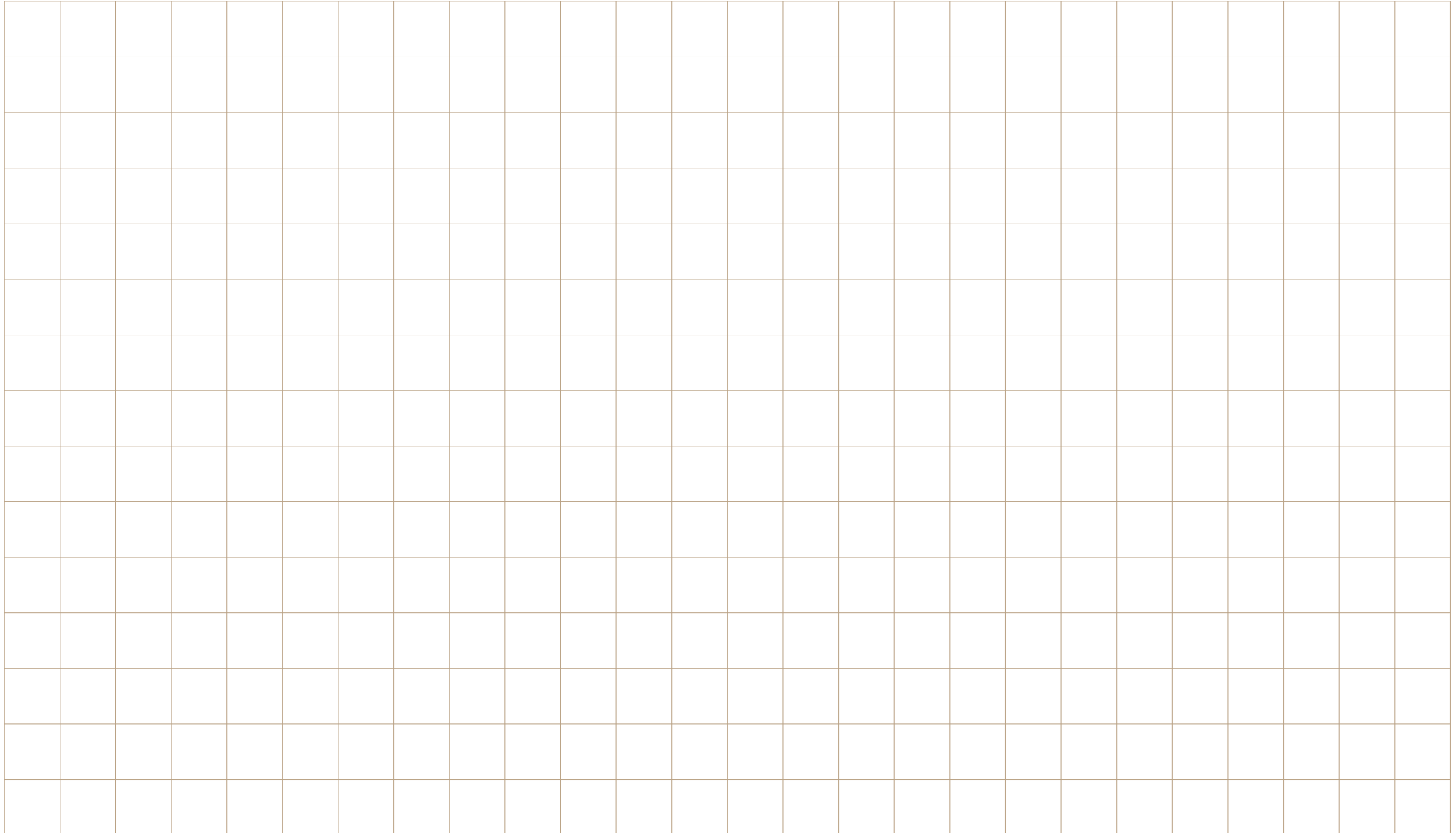

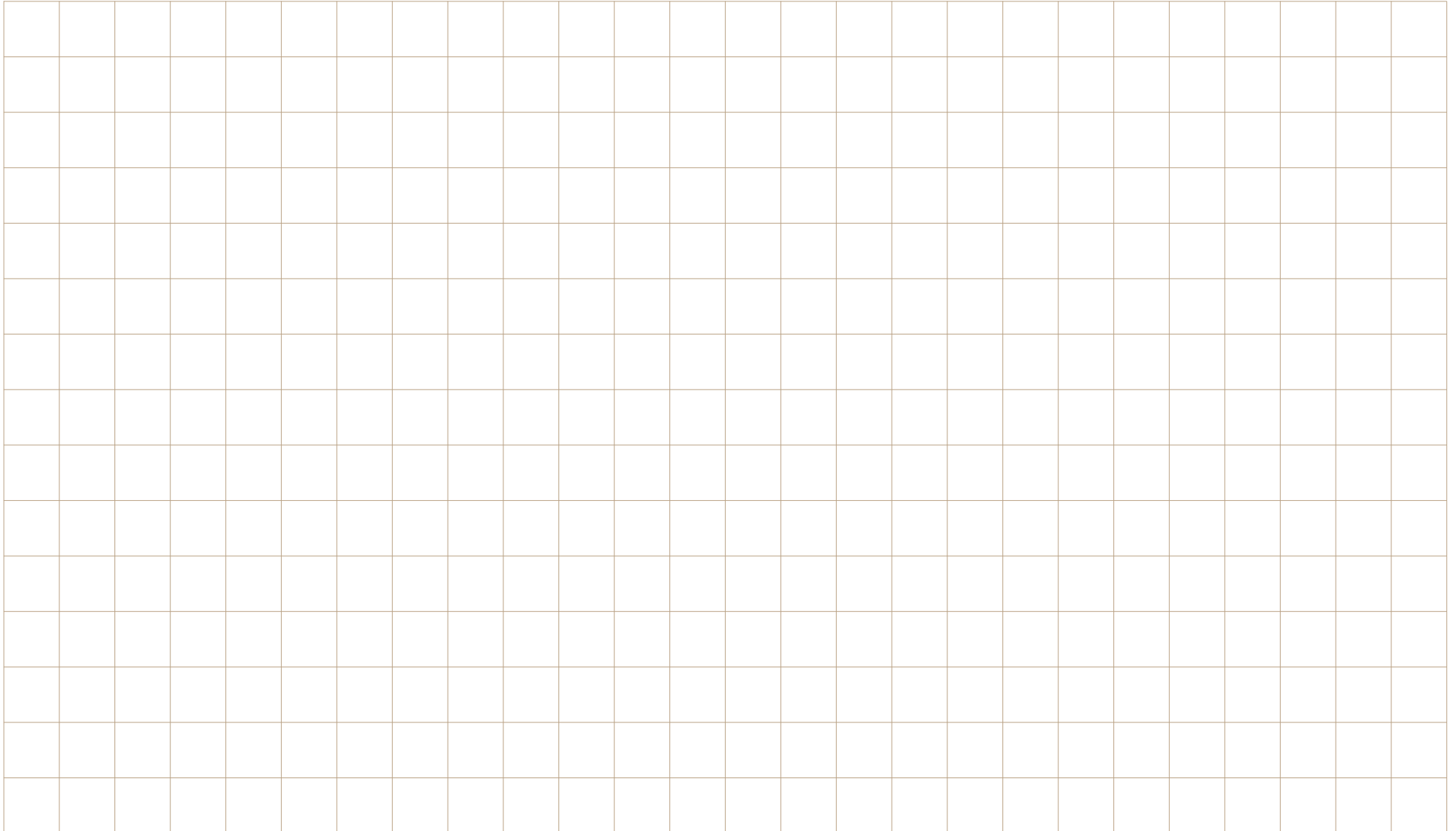

Colophon

Barbas Bellfires

Hallenstraat 17
NL - 5531 AB Bladel
The Netherlands

T + 31 (0)497 33 92 00
info@barbasbellfires.nl
www.barbasbellfires.nl

France:
T + 33 (0)183 792 960
info@barbasbellfires.fr
www.barbasbellfires.com/fr

UK:
T + 44 15 62 54 99 70
info@barbasbellfires.com
www.barbasbellfires.com

■ Disclaimer

Deze brochure is met uiterste zorg samengesteld. Toch bestaat altijd de mogelijkheid dat bepaalde informatie verouderd of niet langer compleet is. Barbas Bellfires is niet verantwoordelijk voor beslissingen die enkel en alleen op basis van deze brochure genomen zijn. Barbas Bellfires adviseert daarom altijd eerst professioneel en deskundig advies in te winnen.

Aan gepubliceerde foto's kunnen geen rechten worden ontleend. Ze zijn uitsluitend bedoeld om een sfeerimpressie van mogelijke opstellingen te tonen.

■ Disclaimer

Cette brochure a été réalisée avec le plus grand soin. Malgré cela, il se peut toujours que certaines informations soient obsolètes ou ne soient plus complètes. Barbas Bellfires décline toute responsabilité pour des décisions prises uniquement sur la base de cette brochure. Par conséquent, Barbas Bellfires recommande de toujours solliciter au préalable un avis professionnel et compétent.

Les photos publiées ne confèrent aucun droit. Elles sont uniquement destinées à donner une impression d'ambiance des configurations possibles.

■ Disclaimer

This brochure was put together with utmost care. Nevertheless, there is always the possibility that certain information is outdated or no longer complete. Barbas Bellfires is not responsible for decisions made based only on the brochure. That is why Barbas Bellfires always advises you to first gather professional and expert advice.

No rights can be derived from the photos published. They are intended exclusively for giving an impression of the atmosphere and of possible set-ups.

■ Disclaimer

Questa brochure è stata redatta con grande cura. Tuttavia può accadere che alcune informazioni non siano aggiornate o complete. Barbas Bellfires non è responsabile di decisioni prese solo ed esclusivamente sulla base di questa brochure. Barbas Bellfires consiglia perciò di rivolgersi sempre per una consulenza ad un professionista esperto.

Nessun diritto può derivare dalle foto pubblicate. Queste sono esclusivamente a scopo dimostrativo delle possibili configurazioni e dell'ambientazione del prodotto.

bellfires. gas fires